





BIENVENIDO Respetando la naturaleza, trabajando en un entorno natural intacto, con un recurso natural y regenerativo como el corcho, el linóleo o la madera, creando un ambiente natural genuino con diferentes líneas de productos de pavimentos, aunado a una filosofía innovadora orientada al cliente ... eso es LICO ... ese es el concepto puro en el que se basa nuestro éxito. Desde 1989, LICO ha pasado de ser una modesta empresa de producción a convertirse en un referente del mercado mundial, moderno, exitoso e innovador. LICO es ahora una de las empresas líderes dentro de la industria de los pavimentos, por su alta calidad, gran flexibilidad, continua innovación y la confianza de un producto *made in europe*. Gracias a su continuo desarrollo de sistemas de producción, LICO es capaz de cumplir con los requisitos globales de la industria de los pavimentos.

BEM-VINDO Respeitar a natureza, trabalhar num ambiente natural intacto, com um recurso natural e regenerativo como a cortiça, o linóleo ou a madeira, criar um ambiente genuinamente natural com diferentes linhas de produtos para pavimentos, aliado a uma filosofia inovadora orientada para o cliente... LICO... esse é o conceito puro em que se baseia o nosso sucesso. Desde 1989, a LICO deixou de ser uma empresa de produção modesta para se tornar uma líder de mercado global moderna, bem-sucedida e inovadora. A LICO é hoje uma das empresas líderes na indústria de pavimentos, pela sua elevada qualidade, grande flexibilidade, inovação contínua e pela confiança de um produto fabricado na Europa. Graças ao desenvolvimento contínuo de sistemas de produção, a LICO é capaz de satisfazer os requisitos globais da indústria de pavimentos.

PRODUCCIÓN EN EL CORAZÓN DE EUROPA
PRODUÇÃO NO CORAÇÃO DA EUROPA

-  Swiss Quality
-  Producción autosuficiente de energía
Produção de energia autossuficiente
-  Cadenas de suministro flexibles
Cadeias de abastecimento flexíveis
-  Cero residuos - 100% de reciclaje de residuos de producción
Desperdício zero - 100% de reciclagem dos resíduos de produção
-  Evitar transporte en el extranjero
Evite transporte para o exterior
-  En continua innovación
Em inovação contínua



O inovador processo de 2nd life abre novas possibilidades no campo da sustentabilidade e da reciclagem, poupando recursos:

ECONOMÍA CIRCULAR SOSTENIBLE
ECONOMIA CIRCULAR SUSTENTÁVEL

El innovador proceso 2nd life abre nuevas posibilidades en el campo de la sostenibilidad y el reciclaje, ahorrando recursos.

Si el antiguo pavimento se ha desgastado o si quiere cambiar su diseño por uno nuevo, el cliente devuelve el pavimento con clic. 1. Se entrega el antiguo pavimento al distribuidor. 2. El pavimento se envía a fábrica. 3. En fábrica, se lija el diseño antiguo, luego se vuelve a imprimir con un nuevo diseño, se recubre con el protector y se perfila. Finalmente, el nuevo pavimento se vuelve a introducir en el mercado, volviendo a ser un suelo de alta calidad.

O inovador processo de 2nd life abre novas possibilidades no campo da sustentabilidade e da reciclagem, poupando recursos.

Se o piso antigo estiver desgastado ou se você quiser trocar seu design por um novo, o cliente devolve o piso com um clique. 1. O pavimento antigo é entregue ao distribuidor. 2. O piso é enviado para a fábrica. 3. Na fábrica, o desenho antigo é lixado, depois reimpresso com um novo desenho, revestido com protetor e perfilado. Por fim, o novo pavimento é reintroduzido no mercado, sendo mais uma vez um pavimento de elevada qualidade.

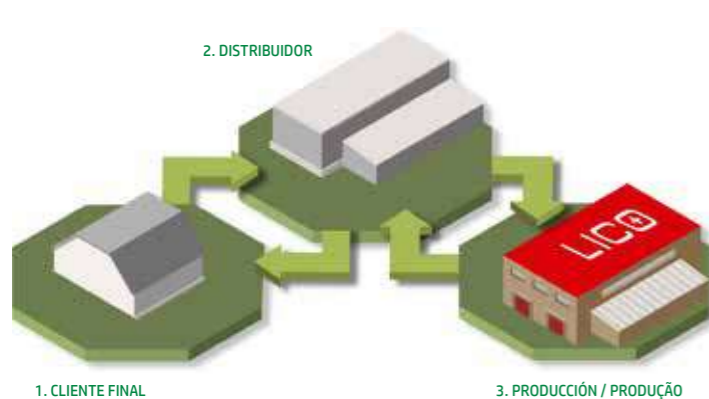

Design

Suelos Vinyl Clase 32 / Capa de uso 0,30 mm / Pisos Vinyl Classe 32 / Camada de desgaste 0,30 mm

Vinyl Economy Plus	08
Vinyl Design 16	12
Vinyl Design Plus	14
Vinyl Swiss Edition	16
Vinyl Design 21	18
Vinyl Design 23	20
Vinyl Conceptfloor	22
Vinyl Kampus	24

Suelos Vinyl Clase 33 / Capa de uso 0,55 mm / Pisos Vinyl Classe 33 / Camada de desgaste 0,55 mm

Vinyl Object 24	26
Vinyl Object	28
Vinyl Object Syncro	32
Vinyl Stone Plus	34
Vinyl Longus	38

Suelos Hydro Fix Clase 32 / Capa de uso 0,30 mm / Pisos Hydro Fix Clase 32 / Camada de desgaste 0,30 mm

Hydro Fix	44
-----------	----

Suelos Hydro Fix Clase 33 / Capa de uso 0,55 mm / Pisos Hydro Fix Clase 33 / Camada de desgaste 0,55 mm

Hydro Fix Object	48
CONTRACT Hydro Fix Object 24	54

Accesorios

Escaleras / Escadas	58
Zócalos / Soquetes	60

Natural

Cork	64
Printcork	70
Lino	76
Fibrano	82
Ledo	88
Real Designwood	92
Micodur	96

Wallcovering

Wall Hydro	102
Wall Hydro Print / 3D	108



Vinyl Suisse Edition - Royal Oak Brown - 590-2

VINYL

Un pavimento para exigencias extremas

Este suelo con capa superior de vinilo es extremadamente resistente a los arañazos, a la suciedad y muy fácil de mantener.

Está disponible en una amplia gama de diseños y colores: desde tabloncillos de madera antiguos hasta la clásica textura de madera de color roble y decoraciones modernas con aspecto de piedra natural. La superficie estructurada transmite una sensación táctil natural.

Nuestros suelos son totalmente respetuosos con el medio ambiente y no contienen sustancias nocivas para la naturaleza ni para las personas.

Todas estas características combinadas con el aspecto natural del vinilo LICO lo convierten en el piso ideal en todas las áreas que requieren un alto nivel de resiliencia junto con un diseño especial.

Um piso para exigências extremas

Este piso de vinil de camada superior é extremamente resistente a arranhões, sujeira e muito fácil de manter.

Está disponível numa vasta gama de designs e cores: desde tábuas de madeira antigas até texturas clássicas de madeira de carvalho e decorações modernas com aspecto de pedra natural. A superfície estruturada transmite uma sensação tátil natural.

Os nossos pavimentos são totalmente amigos do ambiente e não contêm substâncias nocivas à natureza ou às pessoas.

Todas estas características aliadas ao aspecto natural do vinil LICO tornam-no no pavimento ideal em todas as áreas que requerem um elevado nível de resiliência juntamente com um design especial.

VINYL ECONOMY PLUS 0,30

Un pavimento para exigencias extremas
Um piso para exigências extremas



6501-A Larch Smoked

VINYL ECONOMY PLUS 0,30

Un pavimento para exigencias extremas
Um piso para exigências extremas

6398-A German Oak White



10108-1 Pine White Rustical



6397-A Maple Forest



10205-1 Mountain Larch Limewashed



55309 Oak Classic



6398-B German Oak



6501 Larch Smoked



10109-1 Mountain Larch Nature



10118-1 Walnut Rustical



10204-2 Oak Dark Rustical



6398-B German Oak



6500-14 Turkey Oak Limewashed



6500-B Birch Rustica



7301-8 Oak Elegant Smoked



9531-1 Turkey Oak Old



9531-3 Turkey Oak Nature



Vinyl

Hydro Fix

Accesorios

Cork

Printcork

Lino

Fibrano

Ledo

Real Designwood

Micodur

Wall Hydro

Wall Hydro Print



VINYL ECONOMY PLUS 0,30

Un pavimento para exigencias extremas
Um piso para exigências extremas



Clase 23 / 32
Classe 23 / 32



Libre de ftalato
Livre de ftalatos



Resistencia a la luz >6
Resistência à luz >6



Calefacción por suelo radiante
Aquecimento por piso radiante



Facil mantenimiento
Manutenção fácil

HDF ca. 9,5 mm



Protección de PU resistente
Proteção PU resistente

Vinyl
Vinyl

Tablero de fibra retardante de humedad
Painel de fibra retardador de umidade

Base de corcho
Base de cortiça



Hydrowood ca. 9,5 mm



Protección de PU resistente
Proteção PU resistente

Vinyl
Vinyl

Tablero impermeable a base de madera
Placa impermeável à base de madeira.

Base de corcho
Base de cortiça



Hydro Sound ca. 6,2 mm

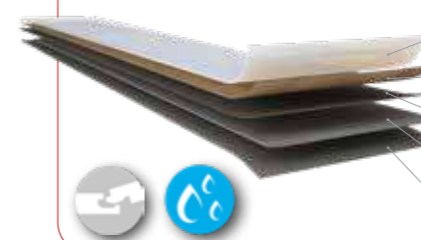

Protección de PU resistente
Proteção PU resistente

Vinyl
Vinyl

Capa elástica
Camada elástica

Tablero con núcleo hidráulico impermeable
Placa central hidráulica à prova d'água

Base Hydro Sound
Base Hydro Sound



Hydro ca. 4,7 mm

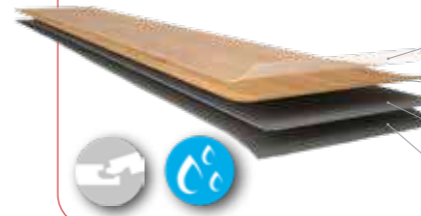

Protección de PU resistente
Proteção PU resistente

Vinyl
Vinyl

Capa elástica
Camada elástica

Tablero con núcleo hidráulico impermeable
Placa central hidráulica à prova d'água



Glue Down ca. 1,5 mm



Protección de PU resistente
Proteção PU resistente

Vinyl
Vinyl



Cálido al tacto
Quente ao toque



Duradero
Durável



Impacto sonoro y aislamiento acústico
Impacto sonoro e isolamento acústico



Antiestático
Antiestático



Aislamiento térmico
Isolamento térmico



Suave a la pisada
Pé macio

Dimensiones / Dimensões

1235 x 230 mm

1235 x 305 mm

VINYL DESIGN 16 0,30

Un pavimento para exigencias extremas
Um piso para exigências extremas

VINYL DESING 16 0,30

Un pavimento para exigencias extremas
Um piso para exigências extremas

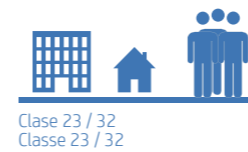

160701 Persian Oak Bleached



1122 Core Beech White



70210 Persian Oak Limewashed



1123-1 White Oak Polar



1123 White Oak Sand



70208 Persian Oak Smoked



1122-2 Walnut



1124-1 Bush Oak Smoked



70012 Wood Pine



3651AB-1 Shingle Oak



61109 Mountain Pine



1122-1 Core Beech



1087-1 Honey Oak



1087-1 Honey Oak



1124-2 Bush Oak



83801 Sea Pine



1133 Rio Palisander



Cálido al tacto
Quente ao toque



Duradero
Durável



Impacto sonoro y aislamiento acústico
Impacto sonoro e isolamento acústico



Antiestático
Antiestático



Aislamiento térmico
Isolamento térmico



Suave a la pisada
Pé macio

Dimensiones / Dimensões

1235 x 230 mm

1235 x 305 mm



Vinyl

Hydro Fix

Accesorios

Cork

Printcork

Lino

Fibrano

Ledo

Real Designwood

Micodur

Wall Hydro

Wall Hydro Print

13

12

VINYL DESIGN PLUS 0,30

Un pavimento para exigencias extremas
Um piso para exigências extremas

VINYL DESING PLUS 0,30

Un pavimento para exigencias extremas
Um piso para exigências extremas

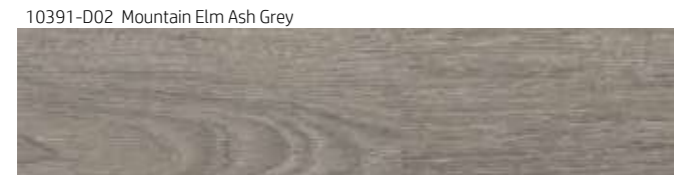

56018 Oak Limewashed



54802 Mountain Spruce White

8242-11 Pearl Oak Limewashed

56018 Oak Limewashed

53030 Apple Tree

82048-4 Oak Traditional

1041-1 Knotty Oak

56153 Birk Old

53008 Old Spruce Nature

53010 Old Spruce Smoked

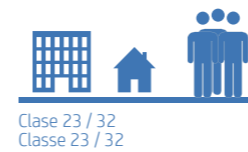

Classe 23 / 32
Classe 23 / 32



Libre de ftalato
Livre de ftalatos



Resistencia a la luz >6
Resistência à luz >6



Calefacción por suelo radiante
Aquecimento por piso radiante



Facil mantenimiento
Manutenção fácil

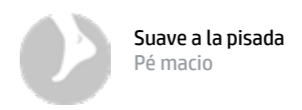
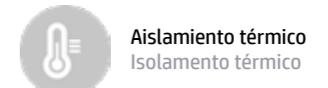
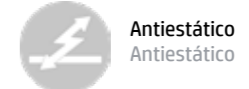
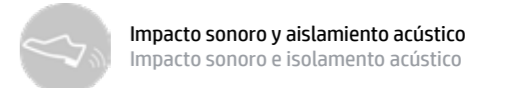

Dimensiones / Dimensões

1235 x 230 mm

1235 x 305 mm



Produced under license of Unilin - EP nr. 0843763/US, patent nr. 6.006.486



Vinyl

Hydro Fix

Accesorios

Cork

Printcork

Lino

Fibrano

Ledo

Real Designwood

Micodur

Wall Hydro

Wall Hydro Print

Wall Hydro Print

VINYL SWISS EDITION 0,30

Diseño para impresionar
Projete para impressionar

VINYL SWISS EDITION 0,30

Diseño para impresionar
Projete para impressionar



590-7 Royal Oak Light



590-15 Royal Oak Dark



590-5 Royal Oak Grey



590-2 Royal Oak Brown



590-4 Royal Oak Natural



590-7 Royal Oak Light



590-3 Royal Oak White



Clase 23 / 32
Classe 23 / 32



Libre de ftalato
Livre de ftalatos



Resistencia a la luz >6
Resistência à luz >6



Calefacción por suelo radiante
Aquecimento por piso radiante



Facil mantenimiento
Manutenção fácil

HDF ca. 9,8 mm

- Protección de PU resistente
Proteção PU resistente
- Vinyl
Vinyl
- Tablero de fibra retardante de humedad
Painel de fibra retardador de umidade
- Base de corcho
Base de cortiça

Hydrowood ca. 9,8 mm

- Protección de PU resistente
Proteção PU resistente
- Vinyl
Vinyl
- Tablero impermeable a base de madera
Placa impermeável à base de madeira.
- Base de corcho
Base de cortiça

Hydro Sound ca. 6,5 mm

- Protección de PU resistente
Proteção PU resistente
- Vinyl
Vinyl
- Capa elástica
Camada elástica
- Tablero con núcleo hidráulico impermeable
Placa central hidráulica à prova d'água
- Base Hydro Sound
Base Hydro Sound

Hydro ca. 5 mm

- Protección de PU resistente
Proteção PU resistente
- Vinyl
Vinyl
- Capa elástica
Camada elástica
- Tablero con núcleo hidráulico impermeable
Placa central hidráulica à prova d'água

Glue Down ca. 1,8 mm

- Protección de PU resistente
Proteção PU resistente
- Vinyl
Vinyl

Cálido al tacto
Quente ao toque

Duradero
Durável

Impacto sonoro y aislamiento acústico
Impacto sonoro e isolamento acústico

Antiestático
Antiestático

Aislamiento térmico
Isolamento térmico

Suave a la pisada
Pé macio

Dimensiones / Dimensões

1235 x 230 mm

1235 x 305 mm



Vinyl

Hydro Fix

Accesorios

Cork

Printcork

Lino

Fibrano

Ledo

Real Designwood

Micodur

Wall Hydro

Wall Hydro Print

17

VINYL DESIGN 21 0,30

Diseño para impresionar
Projete para impressionar

VINYL DESIGN 21 0,30

Diseño para impresionar
Projete para impressionar

21006 Autumn Oak Creme



21004 Oak Umber



21003 Oak Highlands



21007 Autumn Oak



21006 Autumn Oak Creme



21002 Desert Maple



21001 Lotus Oak



21005 Oak Dakota



21008 Fog Oak



Clase 23 / 32
Classe 23 / 32



Libre de ftalato
Livre de ftalatos



Resistencia a la luz >6
Resistência à luz >6



Calefacción por suelo radiante
Aquecimento por piso radiante



Facil mantenimiento
Manutenção fácil

HDF ca. 9,5 mm

- Protección de PU resistente
Proteção PU resistente
- Vinyl
Vinyl
- Tablero de fibra retardante de humedad
Painel de fibra retardador de umidade
- Base de corcho
Base de cortiça

Hydrowood ca. 9,5 mm

- Protección de PU resistente
Proteção PU resistente
- Vinyl
Vinyl
- Tablero impermeable a base de madera
Placa impermeável à base de madeira.
- Base de corcho
Base de cortiça

Hydro Sound ca. 6,2 mm

- Protección de PU resistente
Proteção PU resistente
- Vinyl
Vinyl
- Capa elástica
Camada elástica
- Tablero con núcleo hidráulico impermeable
Placa central hidráulica à prova d'água
- Base Hydro Sound
Base Hydro Sound

Hydro ca. 4,7 mm

- Protección de PU resistente
Proteção PU resistente
- Vinyl
Vinyl
- Capa elástica
Camada elástica
- Tablero con núcleo hidráulico impermeable
Placa central hidráulica à prova d'água

Glue Down ca. 2,5 mm

- Protección de PU resistente
Proteção PU resistente
- Vinyl
Vinyl

Cálido al tacto
Quente ao toque

Duradero
Durável

Impacto sonoro y aislamiento acústico
Impacto sonoro e isolamento acústico

Antiestático
Antiestático

Aislamiento térmico
Isolamento térmico

Suave a la pisada
Pé macio

Dimensiones / Dimensões

1235 x 230 mm

1235 x 305 mm



Produced under license of Unilin - EP nr. 0843763/US, patent nr. 6.006.486



SGS Global Services

Vinyl

Hydro Fix

Accesorios

Cork

Printcork

Lino

Fibrano

Ledo

Real Designwood

Micodur

Wall Hydro

Wall Hydro Print

19

18

VINYL DESIGN 23 0,30

Diseño para impresionar
Projete para impressionar

VINYL DESIGN 23 0,30

Diseño para impresionar
Projete para impressionar

23001 Alpine Spruce White



23003 Walnut Eterna



23005 Beech Nature



22007 Cognac Oak Nature



23002 Alpine Spruce Nature



22008 Cognac Oak Light



23001 Alpine Spruce White



23004 Aged Spruce



23006 Beech White



Clase 23 / 32
Classe 23 / 32



Libre de ftalato
Livre de ftalatos



Resistencia a la luz >6
Resistência à luz >6



Calefacción por suelo radiante
Aquecimento por piso radiante



Facil mantenimiento
Manutenção fácil

HDF ca. 9,8 mm

- Protección de PU resistente
Proteção PU resistente
- Vinyl
Vinyl
- Tablero de fibra retardante de humedad
Painel de fibra retardador de umidade
- Base de corcho
Base de cortiça

Hydrowood ca. 9,8 mm

- Protección de PU resistente
Proteção PU resistente
- Vinyl
Vinyl
- Tablero impermeable a base de madera
Placa impermeável à base de madeira.
- Base de corcho
Base de cortiça

Hydro Sound ca. 6,5 mm

- Protección de PU resistente
Proteção PU resistente
- Vinyl
Vinyl
- Capa elástica
Camada elástica
- Tablero con núcleo hidráulico impermeable
Placa central hidráulica à prova d'água
- Base Hydro Sound
Base Hydro Sound

Hydro ca. 5 mm

- Protección de PU resistente
Proteção PU resistente
- Vinyl
Vinyl
- Capa elástica
Camada elástica
- Tablero con núcleo hidráulico impermeable
Placa central hidráulica à prova d'água

Glue Down ca. 1,8 mm

- Protección de PU resistente
Proteção PU resistente
- Vinyl
Vinyl

Cálido al tacto
Quente ao toque

Duradero
Durável

Impacto sonoro y aislamiento acústico
Impacto sonoro e isolamento acústico

Antiestático
Antiestático

Aislamiento térmico
Isolamento térmico

Suave a la pisada
Pé macio

Dimensiones / Dimensões

1235 x 230 mm

1235 x 305 mm



Vinyl

Hydro Fix

Accesorios

Cork

Printcork

Lino

Fibrano

Ledo

Real Designwood

Micodur

Wall Hydro

Wall Hydro Print

21

20

VINYL CONCEPTFLOOR 0,30

Diseño para impresionar
Projete para impressionar

VINYL CONCEPTFLOOR 0,30

Diseño para impresionar
Projete para impressionar



6357-C Oak Muscat

13001 Oak Noblesse



6248 Oak Gris



6357-C Oak Muscat



6386-3 Mountain Chestnut



179-02 Oak Brugg



190L-04 Oak Davos



Clase 23 / 32
Classe 23 / 32

Libre de ftalato
Livre de ftalatos

Resistencia a la luz >6
Resistência à luz >6

Calefacción por suelo radiante
Aquecimento por piso radiante

Facil mantenimiento
Manutenção fácil

HDF ca. 9,5 mm

- Protección de PU resistente
Proteção PU resistente
- Vinyl
Vinyl
- Tablero de fibra retardante de humedad
Painel de fibra retardador de umidade
- Base de corcho
Base de cortiça

Hydrowood ca. 9,5 mm

- Protección de PU resistente
Proteção PU resistente
- Vinyl
Vinyl
- Tablero impermeable a base de madera
Placa impermeável à base de madeira.
- Base de corcho
Base de cortiça

Hydro Sound ca. 6,2 mm

- Protección de PU resistente
Proteção PU resistente
- Vinyl
Vinyl
- Capa elástica
Camada elástica
- Tablero con núcleo hidráulico impermeable
Placa central hidráulica à prova d'água
- Base Hydro Sound
Base Hydro Sound

Hydro ca. 4,7 mm

- Protección de PU resistente
Proteção PU resistente
- Vinyl
Vinyl
- Capa elástica
Camada elástica
- Tablero con núcleo hidráulico impermeable
Placa central hidráulica à prova d'água

Glue Down ca. 1,5 mm

- Protección de PU resistente
Proteção PU resistente
- Vinyl
Vinyl

Cálido al tacto
Quente ao toque

Duradero
Durável

Impacto sonoro y aislamiento acústico
Impacto sonoro e isolamento acústico

Antiestático
Antiestático

Aislamiento térmico
Isolamento térmico

Suave a la pisada
Pé macio

Dimensiones / Dimensões

1235 x 230 mm

1235 x 305 mm



Vinyl

Hydro Fix

Accesorios

Cork

Printcork

Lino

Fibrano

Ledo

Real Designwood

Micodur

Wall Hydro

Wall Hydro Print

VINYL KAMPUS 0,30

Diseño para impresionar
Projete para impressionar

VINYL KAMPUS 0,30

Diseño para impresionar
Projete para impressionar



5002 Oak Summer

5001 Oak Spring



5002 Oak Summer



5003 Oak Autumn



Clase 23 / 32
Classe 23 / 32



Libre de ftalato
Livre de ftalatos



Resistencia a la luz >6
Resistência à luz >6



Calefacción por suelo radiante
Aquecimento por piso radiante



Facil mantenimiento
Manutenção fácil

HDF ca. 9,5 mm

- Protección de PU resistente
Proteção PU resistente
- Vinyl
Vinyl
- Tablero de fibra retardante de humedad
Painel de fibra retardador de umidade
- Base de corcho
Base de cortiça

Hydrowood ca. 9,5 mm

- Protección de PU resistente
Proteção PU resistente
- Vinyl
Vinyl
- Tablero impermeable a base de madera
Placa impermeável à base de madeira.
- Base de corcho
Base de cortiça

Hydro Sound ca. 6,2 mm

- Protección de PU resistente
Proteção PU resistente
- Vinyl
Vinyl
- Capa elástica
Camada elástica
- Tablero con núcleo hidráulico impermeable
Placa central hidráulica à prova d'água
- Base Hydro Sound
Base Hydro Sound

Hydro ca. 4,7 mm

- Protección de PU resistente
Proteção PU resistente
- Vinyl
Vinyl
- Capa elástica
Camada elástica
- Tablero con núcleo hidráulico impermeable
Placa central hidráulica à prova d'água

Glue Down ca. 1,5 mm

- Protección de PU resistente
Proteção PU resistente
- Vinyl
Vinyl

Cálido al tacto
Quente ao toque

Duradero
Durável

Impacto sonoro y aislamiento acústico
Impacto sonoro e isolamento acústico

Antiestático
Antiestático

Aislamiento térmico
Isolamento térmico

Suave a la pisada
Pé macio

Dimensiones / Dimensões

915 x 305 mm



Vinyl

Hydro Fix

Accesorios

Cork

Printcork

Lino

Fibrano

Ledo

Real Designwood

Micodur

Wall Hydro

Wall Hydro Print

VINYL OBJECT 24 0,55

Diseño para impresionar
Projete para impressionar

VINYL OBJECT 24 0,55

Diseño para impresionar
Projete para impressionar

24005 Toledo Oak Mokka



24004 Toledo Oak Nature



24001 Toledo Oak Limewashed



24002 Toledo Oak Raw



24003 Savona Oak Dark



24004 Toledo Oak Nature



24005 Toledo Oak Mokka



Clase 23 / 33
Classe 23 / 33



Libre de ftalato
Livre de ftalatos



Resistencia a la luz >6
Resistência à luz >6



Calefacción por suelo radiante
Aquecimento por piso radiante



Facil mantenimiento
Manutenção fácil

HDF ca. 10 mm

- Protección de PU resistente
Proteção PU resistente
- Vinyl
Vinyl
- Tablero de fibra retardante de humedad
Painel de fibra retardador de umidade
- Base de corcho
Base de cortiça

Hydrowood ca. 10 mm

- Protección de PU resistente
Proteção PU resistente
- Vinyl
Vinyl
- Tablero impermeable a base de madera
Placa impermeável à base de madeira.
- Base de corcho
Base de cortiça

Hydro Sound ca. 6,7 mm

- Protección de PU resistente
Proteção PU resistente
- Vinyl
Vinyl
- Capa elástica
Camada elástica
- Tablero con núcleo hidráulico impermeable
Placa central hidráulica à prova d'água
- Base Hydro Sound
Base Hydro Sound

Hydro ca. 5,2 mm

- Protección de PU resistente
Proteção PU resistente
- Vinyl
Vinyl
- Capa elástica
Camada elástica
- Tablero con núcleo hidráulico impermeable
Placa central hidráulica à prova d'água

Glue Down ca. 2 mm

- Protección de PU resistente
Proteção PU resistente
- Vinyl
Vinyl

Cálido al tacto
Quente ao toque

Duradero
Durável

Impacto sonoro y aislamiento acústico
Impacto sonoro e isolamento acústico

Antiestático
Antiestático

Aislamiento térmico
Isolamento térmico

Suave a la pisada
Pé macio

Dimensiones / Dimensões

1235 x 230 mm

1235 x 305 mm



Vinyl

Hydro Fix

Accesorios

Cork

Printcork

Lino

Fibrano

Ledo

Real Designwood

Micodur

Wall Hydro

Wall Hydro Print

27

26

VINYL OBJECT 0,55

Un pavimento para exigencias extremas
Um piso para exigências extremas

637L-07 Oak Müstair



VINYL OBJECT 0,55
Un pavimento para exigencias extremas
Um piso para exigências extremas

82303 Mountain Maple



82387 Pine White



8230-17 Swiss Apple



637L-03 Oak Emmen



8A2195 Cedar



8390-1 Larch Zermatt



637L-07 Oak Müstair



82196 Pine Grey



8176-1 Oak Chur



12591-4 Pine Zug



9013-7 Oak Luzern



8155-10 Red Oak Limewashed



8103-2 Oak St. Gallen



619-01 Kiefer Risch / Pine Risch



8390-8 Lärche Kloten / Larch Kloten



8155-10 Red Oak Limewashed



82407 Schweizer Teak Geräuchert / Swiss Teak Smoked



8176-4 Oak Uster



Vinyl

Hydro Fix

Accesorios

Cork

Printcork

Lino

Fibrano

Ledo

Real Designwood

Micodur

Wall Hydro

Wall Hydro Print

29

8390-1 Larch Zermatt



Clase 23 / 33
 Classe 23 / 33

Libre de ftalato
 Livre de ftalatos

Resistencia a la luz >6
 Resistência à luz >6

Calefacción por suelo radiante
 Aquecimento por piso radiante

Facil mantenimiento
 Manutenção fácil

HDF ca. 10 mm

Protección de PU resistente
 Proteção PU resistente

Vinyl
 Vinyl

Tablero de fibra retardante de humedad
 Painel de fibra retardador de umidade

Base de corcho
 Base de cortiça

Hydrowood ca. 10 mm

Protección de PU resistente
 Proteção PU resistente

Vinyl
 Vinyl

Tablero impermeable a base de madera
 Placa impermeável à base de madeira.

Base de corcho
 Base de cortiça

Hydro Sound ca. 6,7 mm

Protección de PU resistente
 Proteção PU resistente

Vinyl
 Vinyl

Capa elástica
 Camada elástica

Tablero con núcleo hidráulico impermeable
 Placa central hidráulica à prova d'água

Base Hydro Sound
 Base Hydro Sound

Hydro ca. 5,2 mm

Protección de PU resistente
 Proteção PU resistente

Vinyl
 Vinyl

Capa elástica
 Camada elástica

Tablero con núcleo hidráulico impermeable
 Placa central hidráulica à prova d'água

Glue Down ca. 2 mm

Protección de PU resistente
 Proteção PU resistente

Vinyl
 Vinyl

Cálido al tacto
 Quente ao toque

Duradero
 Durável

Impacto sonoro y aislamiento acústico
 Impacto sonoro e isolamento acústico

Antiestático
 Antiestático

Aislamiento térmico
 Isolamento térmico

Suave a la pisada
 Pé macio

Dimensiones / Dimensões

1235 x 230 mm

1235 x 305 mm



Vinyl

Hydro Fix

Accesorios

Cork

Printcork

Lino

Fibrano

Ledo

Real Designwood

Micodur

Wall Hydro

Wall Hydro Print

VINYL OBJECT SYNCRO 0,55

Un pavimento para exigencias extremas
Um piso para exigências extremas

22008 Coagnac Oak Light



VINYL OBJECT SYNCRO 0,55

Un pavimento para exigencias extremas
Um piso para exigências extremas



- Cálido al tacto**
Quente ao toque
- Duradero**
Durável
- Impacto sonoro y aislamiento acústico**
Impacto sonoro e isolamento acústico
- Antiestático**
Antiestático
- Aislamiento térmico**
Isolamento térmico
- Suave a la pisada**
Pé macio

Dimensiones / Dimensões

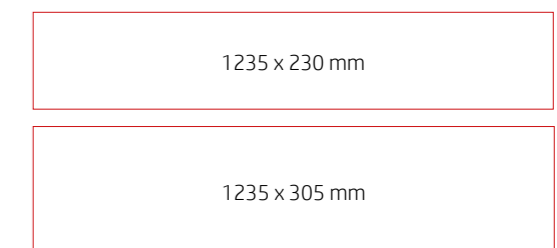

Vinyl

Hydro Fix

Accesorios

Cork

Printcork

Lino

Fibrano

Ledo

Real Designwood

Micodur

Wall Hydro

Wall Hydro Print

2289-3 Concrete Loft Grey



23076-9 Monte Sasso



43201 Cement Steel



3399 Schieferstein



72049 Metallic Black



2289-3 Concrete Loft Grey



56162 Cement Dark



4021-D02 Cement Iron



37702 Slate Silver



38384 Kieselstein



37289 Betonstein



18-1 Black Stone



VINYL STONE PLUS 0,55

Un pavimento para exigencias extremas
 Um piso para exigências extremas

23076-9 Monte Sasso

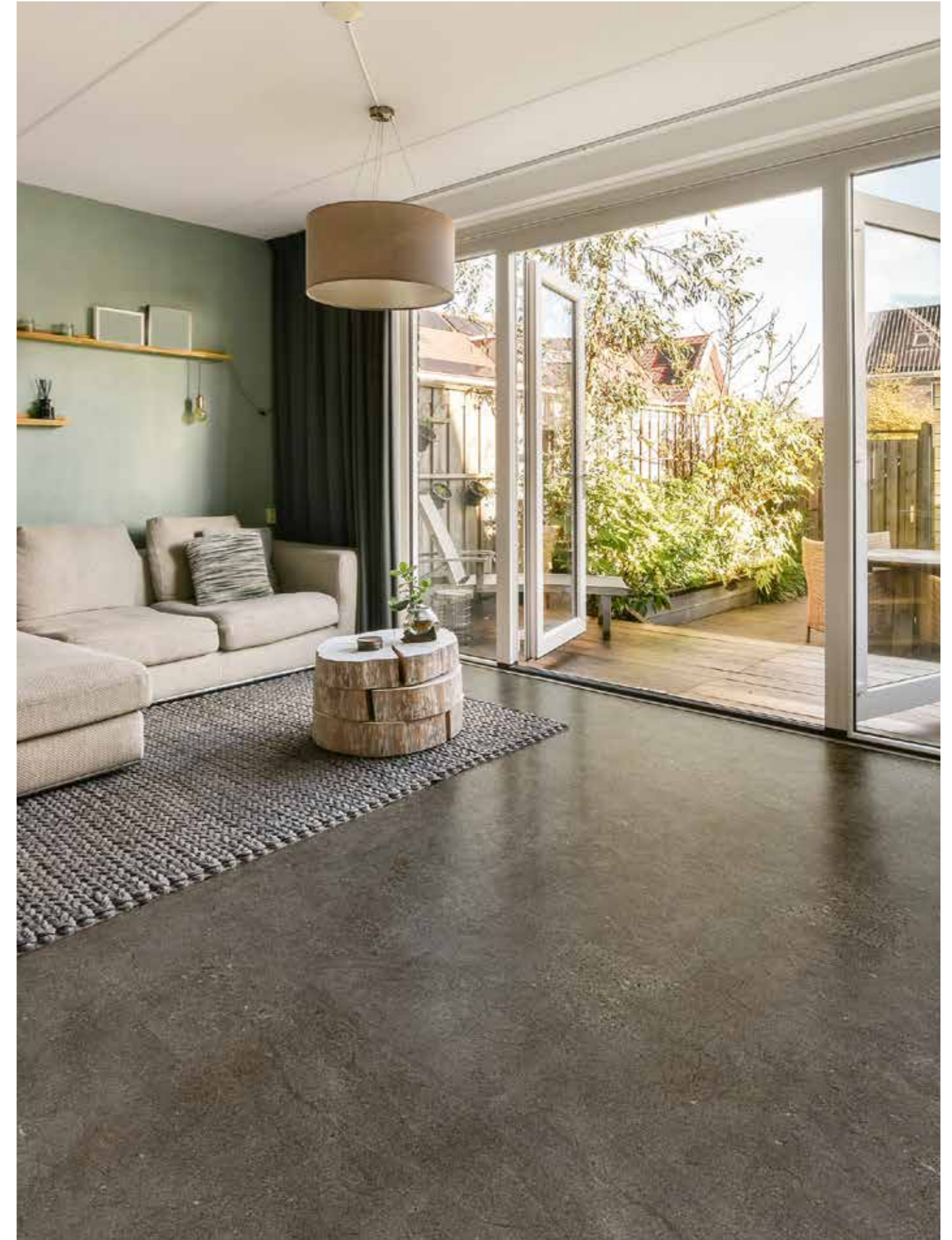

Vinyl

Hydro Fix

Accesorios

Cork

Printcork

Lino

Fibrano

Ledo

Real Designwood

Micodur

Wall Hydro

Wall Hydro Print



77102 Metallic Gold

55436 Neve

1039-6 Marmorstein



2376-3A Monte Sasso Creme

72019 Cement White



66908 Traverto

77802 Sandstone Grey



77102 Metallic Gold

3397-1 Cement Creme



67803 Cotto

23104-1 Persia

6451-9 Cement Copper

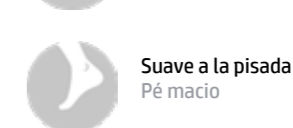
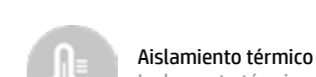
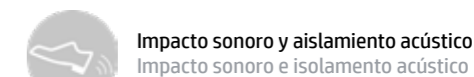
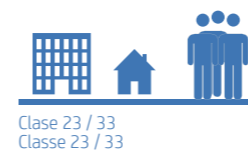

Dimensiones / Dimensões

915 x 305 mm

620 x 450 mm



Vinyl
Hydro Fix
Accesorios
Cork
Printcork
Lino
Fibrano
Ledo
Real Designwood
Micodur
Wall Hydro
Wall Hydro Print

VINYL LONGUS 0,55

Un pavimento para exigencias extremas
Um piso para exigências extremas

503L-01 Sand Oak



VINYL LONGUS 0,55
Un pavimento para exigencias extremas
Um piso para exigências extremas

1112 Downy Oak White



503L-04 Sand Oak Limewashed



503L-05 Oak Smoked



10751A Downy Oak Limewashed



12391-2 Mountain Oak Limewashed



8121-1 - Oak Plains



11391-5 - Oak Terra Nera



1117-1 Larch Antique



503L-09 Oak Smoked Grey



11391-8 Oak Savannah



590-7 Royal Oak Light



501L-03 Silver Oak



3632-15 Stone Oak



503L-01 Sand Oak



21007 Autumn Oak



590-2 Royal Oak Brown



12391-1 Mountain Pine Nature



502L-01 Oak Deluxe



21004 Oak Umber



Vinyl

Hydro Fix

Accesorios

Cork

Printcork

Lino

Fibrano

Ledo

Real Designwood

Micodur

Wall Hydro

Wall Hydro Print

21004 Oak Umber



Clase 23 / 33
Classe 23 / 33



Libre de ftalato
Livre de ftalatos



Resistencia a la luz >6
Resistência à luz >6



Calefacción por suelo radiante
Aquecimento por piso radiante



Facil mantenimiento
Manutenção fácil

HDF ca. 10 mm



Protección de PU resistente
Proteção PU resistente

Vinyl
Vinyl

Tablero de fibra retardante de humedad
Painel de fibra retardador de umidade

Base de corcho
Base de cortiça



NEW Hydrowood ca. 10 mm



Protección de PU resistente
Proteção PU resistente

Vinyl
Vinyl

Tablero impermeable a base de madera
Placa impermeável à base de madeira.

Base de corcho
Base de cortiça



Glue Down ca. 2,0 mm



Protección de PU resistente
Proteção PU resistente

Vinyl
Vinyl



Cálido al tacto
Quente ao toque



Duradero
Durável



Impacto sonoro y aislamiento acústico
Impacto sonoro e isolamento acústico



Antiestático
Antiestático



Aislamiento térmico
Isolamento térmico



Suave a la pisada
Pé macio

Dimensiones / Dimensões

1815 X 230 mm

XL

1815 x 305 mm

XL



Vinyl

Hydro Fix

Accesorios

Cork

Printcork

Lino

Fibrano

Ledo

Real Designwood

Micodur

Wall Hydro

Wall Hydro Print

Wall Hydro Print

Wall Hydro Print

41



590-4 Royal Oak Natural

HYDRO FIX

Un suelo de diseño inteligente

Hydro Fix es el suelo de diseño impermeable, altamente resistente y con sonido de impacto integrado.

Su moderno diseño en madera y piedra y su reducido espesor de construcción convencer en todo momento. Además, Hydro Fix puede marcar con un tacto natural y una superficie estructurada.

La resistencia al agua, la muy alta estabilidad dimensional ante cambios de temperatura y la alta durabilidad hacen que el suelo de diseño sea interesante para todos los ámbitos. Cabe destacar especialmente el sonido de impacto integrado y la capa intermedia elástica. Estos subrayan una agradable comodidad al caminar y distinguen significativamente a Hydro Fix de otros productos.

Um piso com design inteligente

Hydro Fix é o piso de design impermeável, altamente resistente e com som de impacto integrado.

O seu design moderno em madeira e pedra e a sua reduzida espessura de construção convencer em todos os momentos. Além disso, Hydro Fix pode marcar com um toque natural e superfície estruturada.

A resistência à água, a altíssima estabilidade dimensional contra mudanças de temperatura e a alta durabilidade tornam o piso de design interessante para todas as áreas. Digno de nota é o som de impacto integrado e a camada intermediária elástica. Estes sublinham um conforto agradável ao caminhar e distinguem significativamente o Hydro Fix de outros produtos.

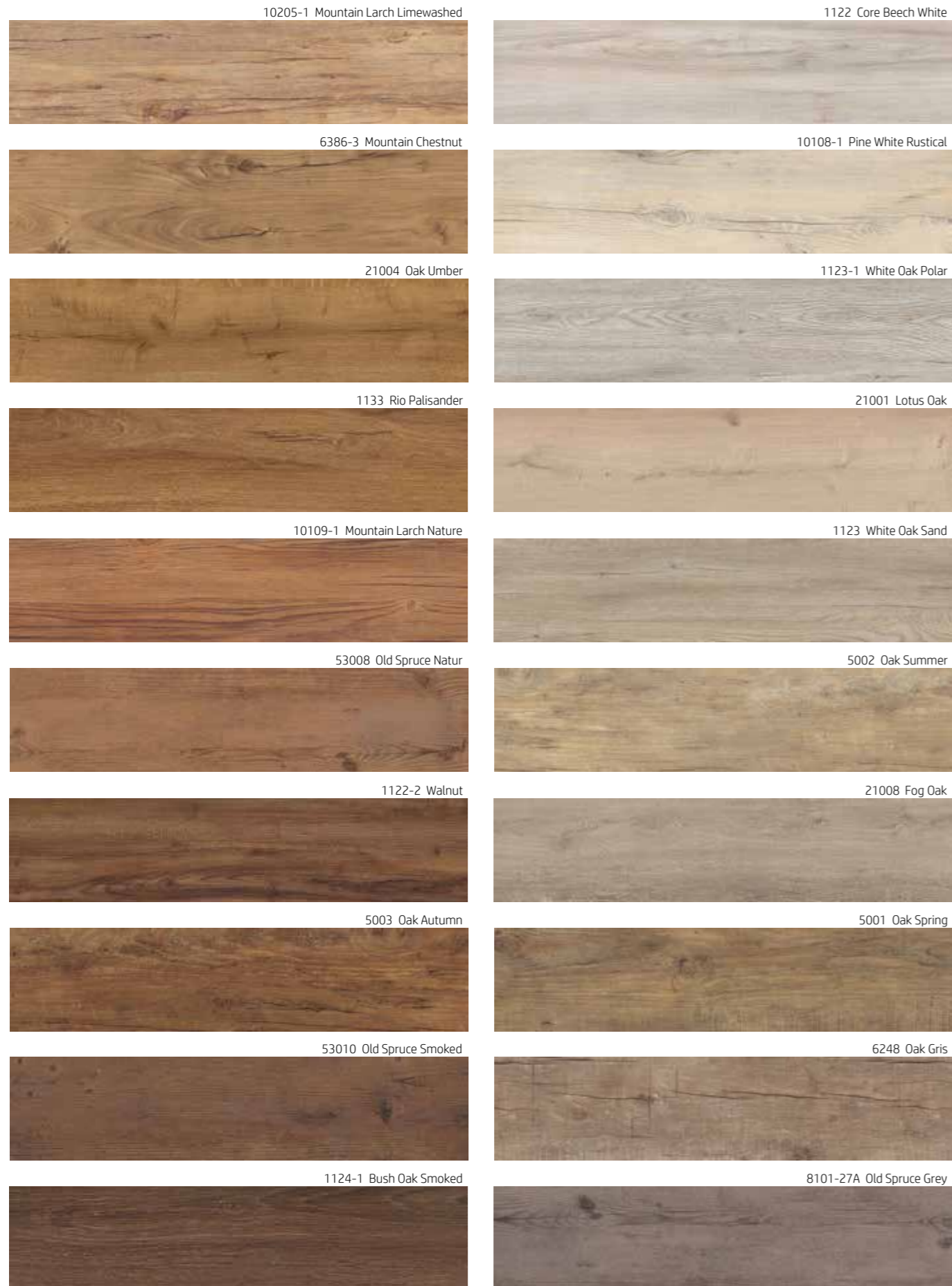

HYDRO FIX S 0,30
 Un suelo de diseño inteligente
 Um piso com design inteligente



Vinyl

Hydro Fix

Accesorios

Cork

Printcork

Lino

Fibrano

Ledo

Real Designwood

Micodur

Wall Hydro

Wall Hydro Print

1087-1 Honey Oak



Clase 23 / 32
Classe 23 / 32



Libre de ftalato
Livre de ftalatos



Resistencia a la luz >6
Resistência à luz >6



Calefacción por suelo radiante
Aquecimento por piso radiante



Impermeable
À prova d'água

Hydro Fix ca. 5,5 mm



Protección de PU resistente
Proteção PU resistente
Capa de desgaste
Camada de desgaste
Diseño decorativo
Desenho decorativo
Respaldo elástico
Encosto elástico
Tablero de núcleo hidráulico impermeable
Placa central hidráulica à prova d'água
Base acústica impermeable
Base acústica impermeável

Hydro Fix S ca. 5,4 mm

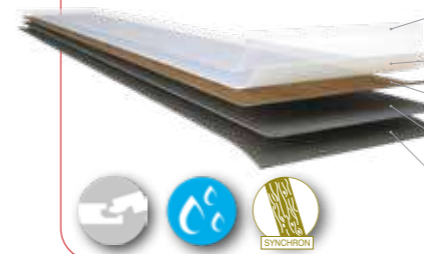

Protección de PU resistente
Proteção PU resistente
Capa de desgaste
Camada de desgaste
Diseño decorativo
Desenho decorativo
Tablero de núcleo hidráulico impermeable
Placa central hidráulica à prova d'água
Base acústica impermeable
Base acústica impermeável

Cálido al tacto
Quente ao toque

Duradero
Durável

Impacto sonoro y aislamiento acústico
Impacto sonoro e isolamento acústico

Antiestático
Antiestático

Aislamiento térmico
Isolamento térmico

Suave a la pisada
Pé macio

6386-3 Mountain Chestnut



Dimensiones / Dimensões

1235 x 230 mm

1235 x 305 mm



HYDRO FIX OBJECT 0,55

Un suelo de diseño inteligente
Um piso com design inteligente



190L-04 Oak Davos

HYDRO FIX OBJECT 0,55

Un suelo de diseño inteligente
Um piso com design inteligente

637L-03 Oak Emmen



8176-4 Oak Uster



6311-2 Oak Locarno



190L-04 Oak Davos



8390-1 Larch Zermatt



637L-07 Oak Müstair



12591-4 Pine Zug



8103-2 Oak St. Gallen



191-08 Old Wood Sitten



3651AB-1 Shingle Oak



619-01 Pine Risch



179-02 Oak Brugg



8390-8 Larch Kloten



8176-1 Oak Chur



191-01 Old Wood Thun



9013-7 Oak Luzern



Vinyl

Hydro Fix

Accesorios

Cork

Printcork

Lino

Fibrano

Ledo

Real Designwood

Micodur

Wall Hydro

Wall Hydro Print

HYDRO FIX S OBJECT 0,55

Un suelo de diseño inteligente
Um piso com design inteligente

23076-3A Monte Sasso Creme



1039-6 S Marmorstein



23076-3A Monte Sasso Creme

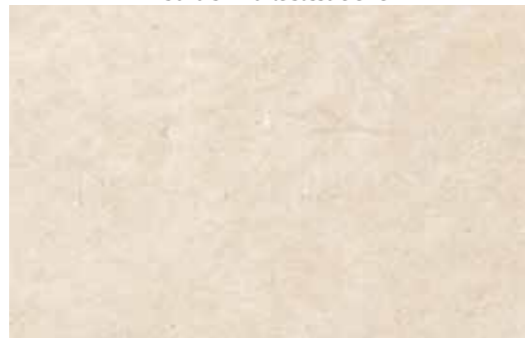

949 Marmor Calacatta



2124-31 Cement Light

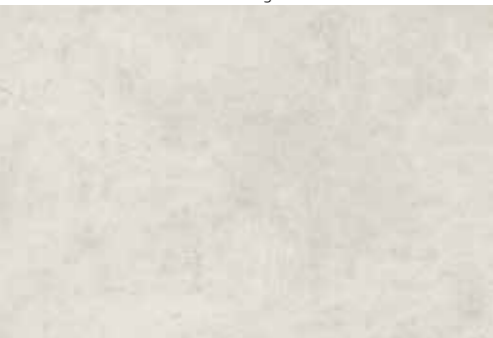

2124-32 Cement grau



3397-1 Cement Creme



23104-1 Persia



4021-D02 Cement Iron



6451-9 Cement Copper

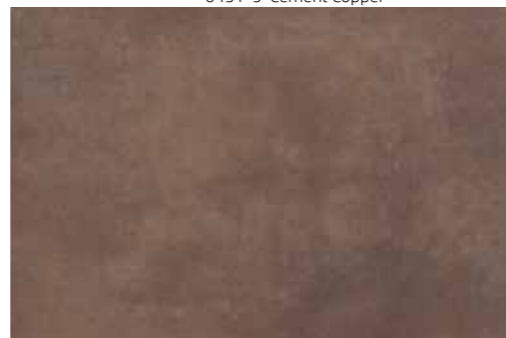

2124-31 Cement Light



38384 S Kieselstein



2289-3 Concrete Loft Grey



37289 S Betonstein



23076-9 Monte Sasso



1361-37 Cement Anthrazit



3399 S Schieferstein



Vinyl

Hydro Fix

Accesorios

Cork

Printcork

Lino

Fibrano

Ledo

Real Designwood

Micodur

Wall Hydro

Wall Hydro Print

51

50



4021-D02 Cement Iron



Clase 23 / 33
Classe 23 / 33



Libre de ftalato
Livre de ftalatos



Resistencia a la luz >6
Resistência à luz >6



Calefacción por suelo radiante
Aquecimento por piso radiante



Impermeable
À prova d'água



Cálido al tacto
Quente ao toque

Duradero
Durável

Impacto sonoro y aislamiento acústico
Impacto sonoro e isolamento acústico

Antiestático
Antiestático

Aislamiento térmico
Isolamento térmico

Suave a la pisada
Pé macio



Dimensiones / Dimensões

620 x 450 mm

1235 x 230 mm

1235 x 305 mm



CONTRACT HYDRO FIX OBJECT 24 0,55

Suelo económico de alta calidad
Piso econômico de alta qualidade

CONTRACT HYDRO FIX OBJECT 24 0,55

Suelo económico de alta calidad
Piso econômico de alta qualidade



24003 Savona Oak Dark



Clase 23 / 33
Classe 23 / 33



Libre de ftalato
Livre de ftalatos



Resistencia a la luz >6
Resistência à luz >6



Calefacción por suelo radiante
Aquecimento por piso radiante



Impermeable
À prova d'água



- Cálido al tacto**
Quente ao toque
- Duradero**
Durável
- Impacto sonoro y aislamiento acústico**
Impacto sonoro e isolamento acústico
- Antiestático**
Antiestático
- Aislamiento térmico**
Isolamento térmico
- Suave a la pisada**
Pé macio

24001 Toledo Oak Limewashed



24002 Toledo Oak Raw



24003 Savona Oak Dark



24004 Toledo Oak Nature



24005 Toledo Oak Mokka



24001 Toledo Oak Limewashed

Dimensiones / Dimensões

1235 x 230 mm

1235 x 305 mm



Vinyl

Hydro Fix

Accesorios

Cork

Printcork

Lino

Fibrano

Ledo

Real Designwood

Micodur

Wall Hydro

Wall Hydro Print

55

54



Escalera clásica con acabado lateral / escada clássica com acabamento lateral
Vinyl Design 16 1122-2 Walnuss

ACCESORIOS ACESSÓRIOS

ESCALERAS ESCADAS

Las escaleras a juego con tu suelo

LICO brinda la posibilidad de conseguir las escaleras con el mismo diseño, estructura, color y longitud que el pavimento seleccionado. Además, mantenemos el mismo sistema clic que el pavimento, con lo que conseguimos una conexión perfecta en todas las direcciones.

Disponible en 2 versiones, ángulo recto o con nariz. Cuando la escalera tiene un lateral visto, existe la opción de acabado lateral.

Escadas para combinar com seu piso

LICO oferece a possibilidade de obter escadas com o mesmo desenho, estrutura, cor e comprimento do pavimento selecionado. Além disso, mantemos o mesmo sistema de clique do pavimento, conseguindo assim uma ligação perfeita em todas as direções.

Disponível em 2 versões, ângulo reto ou nariz. Quando a escada possui a lateral visível, existe a opção de acabamento lateral.

Disponibile en / Disponível em:

DESIGN VINYL

Escalón XXL / Etapa XXL

Profundidad de escalón > 40 cm / Profundidade do passo > 40 cm

* Medidas en mm / Medidas em mm

Escalera clásica
Escada clássica



Longitud de la escalera - tamaño del pavimento
Comprimento da escada - tamanho do pavimento
1800 mm, 1220 mm, 900 mm

Escalera clásica con acabado lateral
Escada clássica com acabamento lateral



Longitud de la escalera - tamaño del pavimento
Comprimento da escada - tamanho do pavimento
ca. 1800 mm, 1220 mm, 900 mm

*El acabado lateral es posible a la izquierda o a la derecha.
O acabamento lateral é possível à esquerda ou à direita.*

Escalera con nariz
Escada com nariz



Longitud de la escalera - tamaño del pavimento
Comprimento da escada - tamanho do pavimento
1800 mm, 1220 mm, 900 mm

Escalera con nariz y acabado lateral
Escada com nariz e acabamento lateral



Longitud de la escalera - tamaño del pavimento
Comprimento da escada - tamanho do pavimento

1800 mm, 1220 mm, 900 mm

*El acabado lateral es posible a la izquierda o a la derecha.
O acabamento lateral é possível à esquerda ou à direita.*



ZÓCALOS RODAPÉS

Zócalos a juego con tu suelo

Los zócalos LICO se pueden adaptar exactamente al suelo, es decir, para cada pavimento LICO hay zócalos idénticos y adecuados que se corresponden con el suelo en diseño, estructura, color y material. Los rodapiés son fáciles de manejar y cuentan con el ya establecido sistema clic, que garantiza una conexión perfecta. Se pueden montar atornillado, pegado y clavado.

Rodapés para combinar com seu piso

Os rodapés LICO podem ser adaptados exactamente ao pavimento, ou seja, para cada pavimento LICO existem rodapés idênticos e adequados que correspondem ao pavimento em design, estrutura, cor e material. Os rodapés são fáceis de manusear e possuem o consagrado sistema click, que garante uma ligação perfeita.

Podem ser montados aparafusando, colando e pregando.

Zócalo cónico
 Rodapé cônico

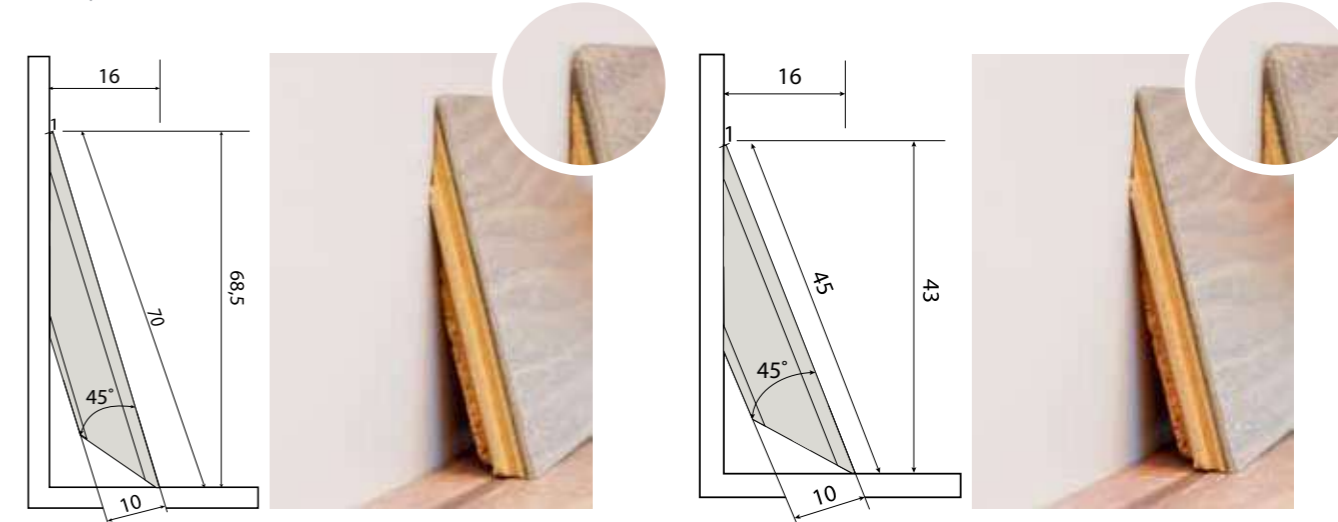

Disponibile en / Disponível em: **todas las líneas de productos / todas as linhas de produtos**

Zócalo clásico
 Rodapé clássico

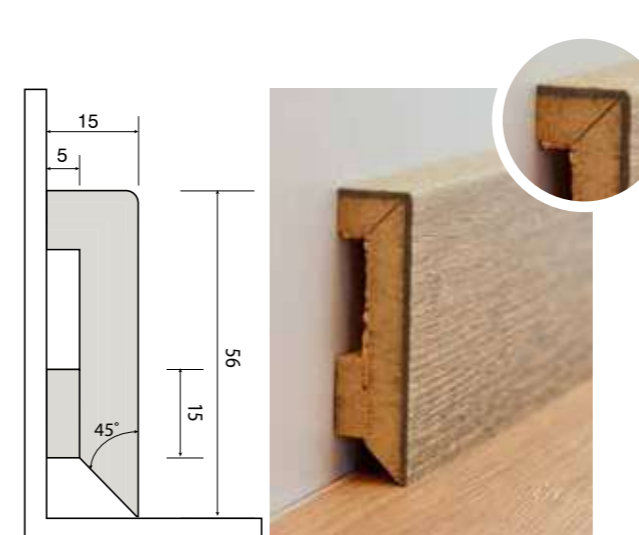

Disponibile en / Disponível em: **DESIGN VINYL**

Zócalo Cónico Abatible
 Rodapé Dobrávei Cônico

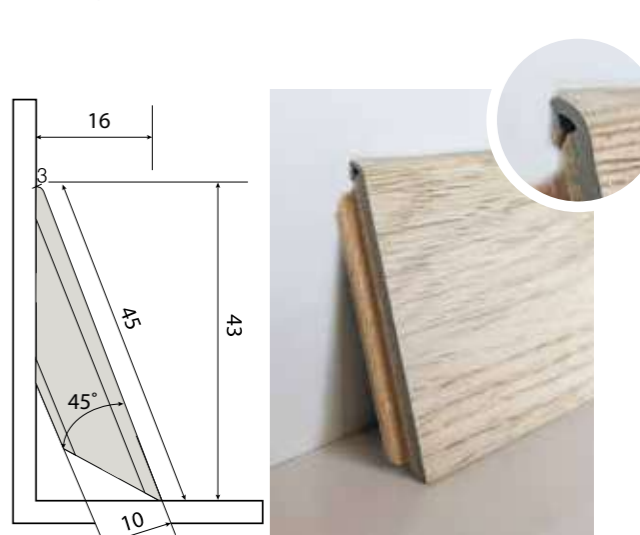

Disponibile en / Disponível em: **DESIGN VINYL**

CORK
PRINCORK
LINO
FIBRANO
LEDO
REALDESIGNWOOD
MICODUR

EN HARMONIA CON EL MEDIO AMBIENTE

Los pavimentos naturales LICO ofrecen una alternativa sostenible y estéticamente agradable en espacios interiores. Los materiales como el corcho, la piel o la piedra, no solo añaden un toque orgánico a la estancia, sino que también promueven la impermeabilidad del suelo, favoreciendo la absorción del agua. Estos pavimentos resaltan la conexión con la naturaleza, creando entornos armoniosos y duraderos.

EM HARMONIA COM O MEIO AMBIENTE

O pavimento natural LICO oferece uma alternativa sustentável e esteticamente agradável em espaços interiores. Materiais como a cortiça, o couro ou a pedra não só conferem um toque orgânico à divisão, como também promovem a impermeabilidade do pavimento, promovendo a absorção de água. Estes pisos realçam a ligação com a natureza, criando ambientes harmoniosos e duradouros.



CORK - Murano

CORK

Una de las maravillas de la naturaleza

El corcho procede de la corteza del alcornoque, un árbol predominantemente mediterráneo, y se extrae sin necesidad de derribar el árbol ni dañarlo de ninguna forma. El primer pelado se produce cuando el árbol tiene unos 25 años y después se puede cosechar una “corteza aislante” cada 8 o 9 años. Los alcornoques pueden vivir hasta 200 años, lo que significa que proporcionan unas veinte cáscaras.

El corcho es una materia prima cien por cien ecológica y debe sus propiedades únicas a su estructura celular de aprox. 40.000 células por cm cuadrado. Las celdas individuales contienen un gas parecido al aire. El corcho es verdaderamente una de las maravillas de la naturaleza y LICO ha desarrollado sus propios procesos de fabricación especiales para garantizar que sus productos cumplan con los exigentes estándares de calidad exigidos por los estándares de calidad suizos.

Uma das maravilhas da natureza

A cortiça provém da casca do sobreiro, árvore predominantemente mediterrânica, e é extraída sem necessidade de derrubar a árvore ou danificá-la de qualquer forma. O primeiro descascamento ocorre quando a árvore tem cerca de 25 anos e depois uma “casca isolante” pode ser colhida a cada 8 ou 9 anos. Os sobreiros podem viver até 200 anos, o que significa que fornecem cerca de vinte conchas.

A cortiça é uma matéria-prima 100% ecológica e deve as suas propriedades únicas à sua estrutura celular de aprox. 40.000 células por cm quadrado. As células individuais contêm um gás semelhante ao ar. A cortiça é verdadeiramente uma das maravilhas da natureza e a LICO desenvolveu os seus próprios processos de fabrico especiais para garantir que os seus produtos cumprem os rigorosos padrões de qualidade exigidos pelos padrões de qualidade suíços.

Quadro

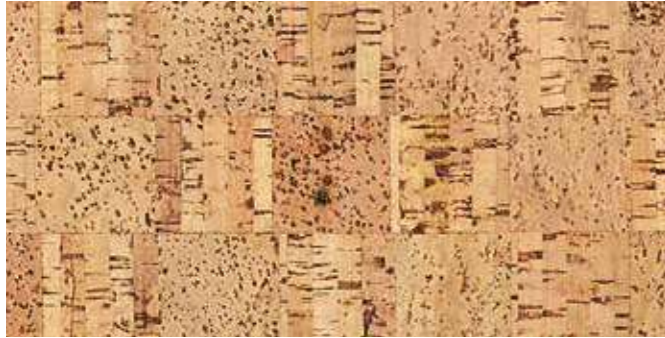

Murano



Mono



Pazzo



Linea



Nostalgie



P-40



Comprido



Flamenco Neu / Flamenco New



Linea Dark



P-999



Rombo New Cherry



Mikado



Elba

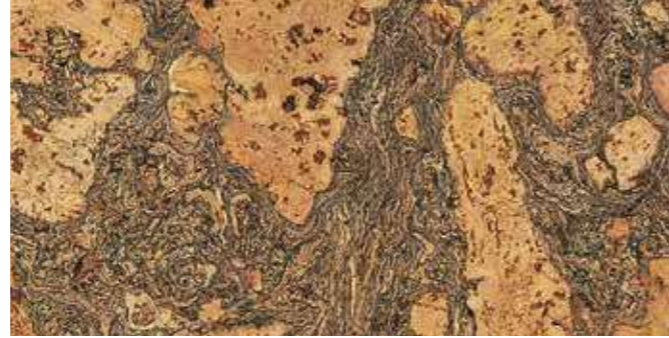

Madeira

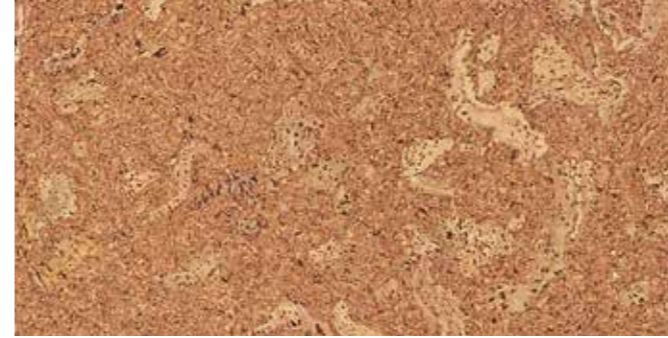

Tigre



Rombo



Mosaik



Rombo New

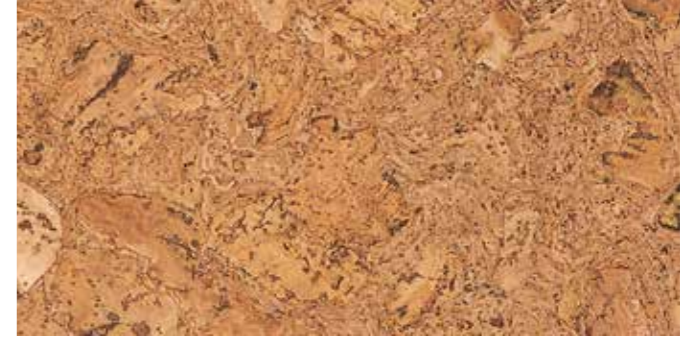

Vinyl

Hydro Fix

Accesorios

Cork

Printcork

Lino

Fibrano

Ledo

Real Designwood

Micodur

Wall Hydro

Wall Hydro Print



Fantasy Natur

i Opciones de color para LICO Cork
Los diseños se pueden colorear en los tonos disponibles.
Opções de cores para LICO Cork
Os desenhos podem ser coloridos nas tonalidades disponíveis.

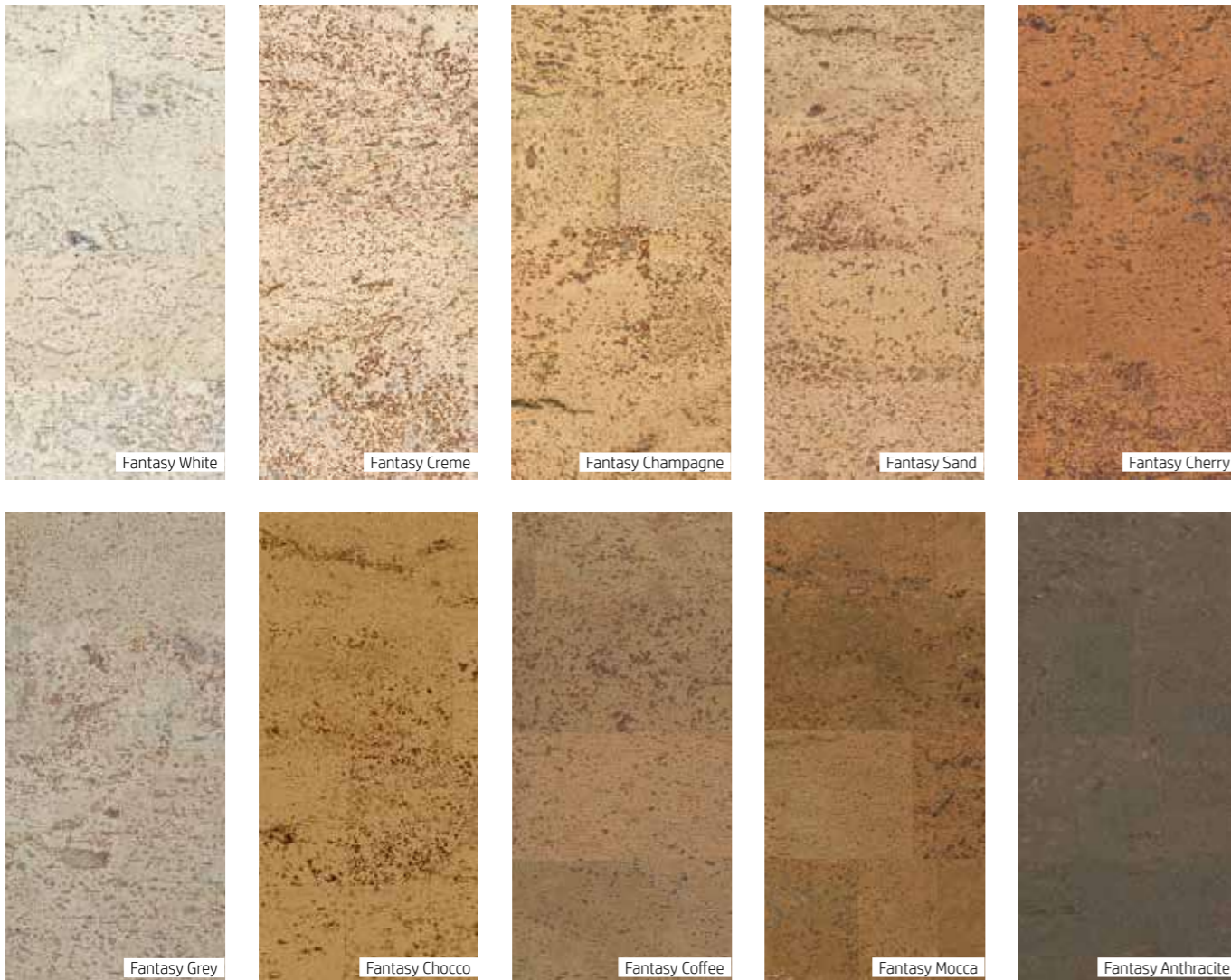

- HC ligera Clase 23 / 32
HC Leve Classe 23/32
- Producto Natural
Produto Natural
- 2nd life
- Impacto Sonoro 18 dB
- Fácil mantenimiento
Manutenção fácil

HDF ca. 11,0 mm

- HotCoating / HotCoating Light
- Chapa de corcho / Folha de cortiça
- Corcho >500 kg/m³ / Cortiça >500 kg/m³
- Tablero de fibra retardante de humedad / Painel de fibra retardador de humidade
- Base de corcho / Base de cortiça

Glue Down ca. 6,0 mm

- HotCoating / HotCoating Light
- Chapa de corcho / Folha de cortiça
- Capa de soporte de corcho / Camada de suporte de cortiça

Glue Down ca. 4,0 mm

- HotCoating / HotCoating Light
- Chapa de corcho / Folha de cortiça
- Capa de soporte de corcho / Camada de suporte de cortiça

- Cálido al tacto**
Quente ao toque
- Resistente**
Durável
- Impacto sonoro y aislamiento acústico.**
Impacto sonoro e isolamento acústico.
- Uso de materia-prima regenerada**
Utilização de matéria-prima regenerada
- Aislamiento térmico**
Isolamento térmico
- Suave a la pisada**
Pé macio
- Apto para calefacción por suelo radiante**
Adequado para piso radiante



Rombo

Dimensiones / Dimensões

915 x 305 mm

600 x 300 mm

UNICLIC Produced under license of Unilin - EP nr. 0843763/AJ.S. patent nr. 6,006,486

Vinyl
Hydro Fix
Accesorios
Cork
Printcork
Lino
Fibrano
Ledo
Real Designwood
Micodur
Wall Hydro
Wall Hydro Print



201547 Classy Oak Honey

PRINTCORK

Una infinita variedad de diseños

Printcork es una línea de productos de suelos de corcho natural, optimizados mediante el uso de compuesto de corcho como revestimiento superior. El uso de la impresión digital abre posibilidades ilimitadas de diseño visual.

Utilizando esta tecnología de impresión especialmente desarrollada y el uso de las últimas tecnologías de recubrimiento, LICO ha logrado crear suelos originales y resistentes. También evita la decoloración cuando se expone a la luz solar directa.

Desde habitaciones infantiles hasta zonas contract: Printcork no tiene límites.

Uma variedade infinita de designs

Printcork é uma linha de pavimentos em cortiça natural, otimizada através da utilização de composto de cortiça como acabamento. O uso da impressão digital abre possibilidades ilimitadas de design visual.

Utilizando esta tecnologia de impressão especialmente desenvolvida e a utilização das mais recentes tecnologias de revestimento, a LICO conseguiu criar pavimentos originais e resistentes. Também evita o desbotamento quando exposto à luz solar direta.

Dos quartos infantis às áreas contratuais: o Printcork não tem limites.



200531 Oak White



201540 Celtic Oak



201550 Northern Oak Sand



201549 Northern Oak Sepia



201551 Northern Oak Silver



201551 Northern Oak Silver



200961 White Oak Sand



201412 Oak Rohne



201548 Classy Oak Porcelain



201470 Lotus Oak



200502 Maple Floor Board



200582 Elm



201547 Classy Oak Honey



201592 Larch Knotty Nature



201565 Oak Europe



201553 Oak Umber Midbrown



201314 Chestnut Soa



201591 Larch Kloten



201547 Classy Oak Honey



201632 Dolomit Oak Sunset



201636 Cortina Oak Bark



201633 Dolomit Oak Ochre



201637 Cortina Oak Oiled



201634 Dolomit Oak Raw



201638 Cortina Oak Alabaster



201635 Dolomit Oak Ivory



200617 Motion

Vinyl

Hydro Fix

Accesorios

Cork

Printcork

Lino

Fibrano

Ledo

Real Designwood

Micodur

Wall Hydro

Wall Hydro Print

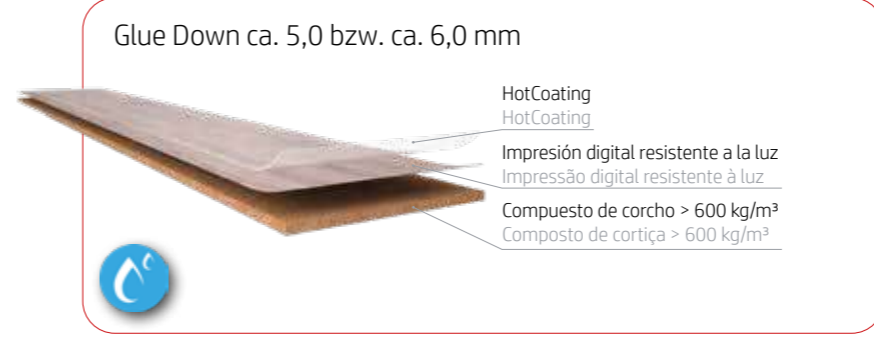
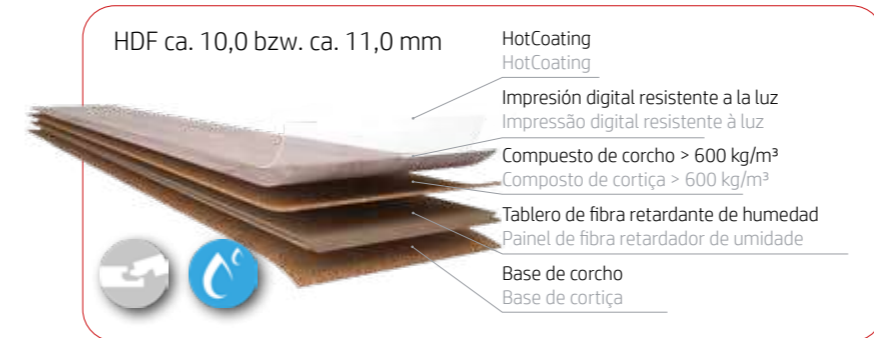

- Cálido al tacto**
Quente ao toque
- Infinita variedad de diseños**
Variedade infinita de designs
- Impacto sonoro y aislamiento acústico.**
Impacto sonoro e isolamento acústico.
- Uso de matéria-prima regenerada**
Utilização de matéria-prima regenerada
- Aislamiento térmico**
Isolamento térmico
- Suave a la pisada**
Pé macio
- Apto para calefacción por suelo radiante**
Adequado para piso radiante

Dimensiones / Dimensões

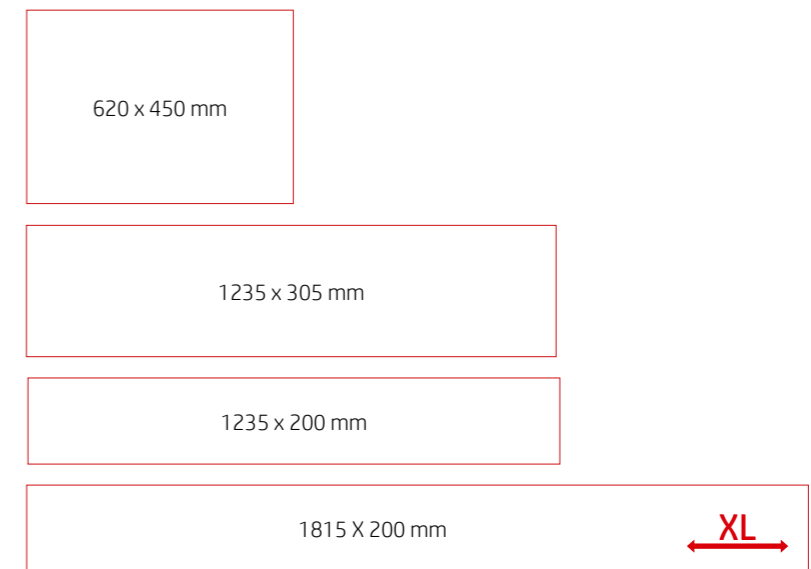

Vinyl

Hydro Fix

Accesorios

Cork

Printcork

Lino

Fibrano

Ledo

Real Designwood

Micodur

Wall Hydro

Wall Hydro Print

75

74



LINO

Linóleo... una asombrosa simbiosis de la naturaleza

El linóleo, un suelo natural probado durante cientos de años, se ha convertido en un revestimiento de suelo muy interesante para una amplia gama de aplicaciones, gracias a las nuevas técnicas de producción. De la habitación de los niños a la oficina y de la consulta del médico a la boutique de diseño.

¿Qué es exactamente el linóleo?

El linóleo se fabrica a partir de aceite de linaza, resina de pino, piedra caliza, harina de alcornoque y colores tierra; como material soporte se utiliza yute. LICO lleva décadas transformando este resistente producto natural en un suelo con un acabado preciso y de alta calidad, conforme a la conciencia de calidad suiza.

Linóleo... uma incrível simbiose da natureza

O linóleo, um pavimento natural comprovado há centenas de anos, tornou-se um revestimento de pavimento muito interessante para uma vasta gama de aplicações, graças às novas técnicas de produção. Do quarto das crianças ao consultório e do consultório médico à boutique de design.

O que exatamente é linóleo?

O linóleo é feito de óleo de linhaça, resina de pinho, calcário, farinha de sobreiro e cores terrosas; A juta é usada como material de suporte. A LICO tem vindo a transformar este produto natural durável num pavimento de alta qualidade com acabamento preciso há décadas, em linha com a consciência de qualidade suíça.

685

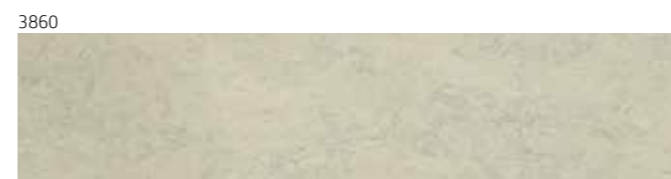

Vinyl

Hydro Fix

Accesorios

Cork

Printcork

Lino

Fibrano

Ledo

Real Designwood

Micodur

Wall Hydro

Wall Hydro Print



3866



Clase 23 / 32
Classe 23/32



Producto Natural
Produto Natural



2nd life



Calefacción por suelo radiante
Aquecimento por piso radiante



Facil mantenimiento
Manutenção fácil

HDF ca. 10,0 mm



Protección de PU resistente
Proteção PU durável
Capa de linóleo
Camada de linóleo
Tablero de fibra retardante de humedad
Painel de fibra retardador de humidade
Base de corcho
Base de cortiça

Glue Down adhesivo / Glue Down adesivo ca. 4,0 mm



Protección de PU resistente
Proteção PU durável
Capa de linóleo
Camada de linóleo
Compuesto de corcho
Composto de cortiça



Cálido al tacto
Quente ao toque



Resistente
Durável



Impacto sonoro y aislamiento acústico.
Impacto sonoro e isolamento acústico.



Uso de matéria-prima regenerada
Utilização de matéria-prima regenerada



Aislamiento térmico
Isolamento térmico



Suave a la pisada
Pé macio

Dimensiones / Dimensões

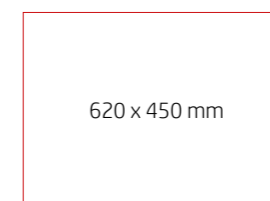
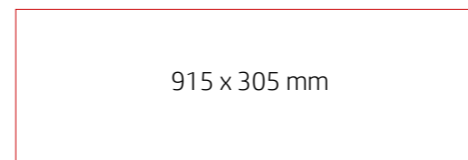

Vinyl

Hydro Fix

Accesorios

Cork

Printcork

Lino

Fibrano

Ledo

Real Designwood

Micodur

Wall Hydro

Wall Hydro Print



201606 Oak Sevilla

FIBRANO

La alternativa natural y sin plástico

Nosotros, como LICO, creemos que es hora de pensar en la sostenibilidad de principio a fin e implementarla en todas sus facetas. Con LICO Fibrano® hemos desarrollado un suelo natural libre de plástico y fabricado exclusivamente a partir de materiales renovables como madera, corcho, fibras naturales, caucho y otras materias primas naturales.

Al mismo tiempo, creamos un revestimiento de suelo moderno, confortable y de alta calidad que cumple con todos los requisitos técnicos del siglo XXI, incluso en términos de robustez (clase 33).

Durante el desarrollo del producto se puso especial énfasis en una economía circular sostenible (2nd life).

A alternativa natural e sem plástico

Nós, como LICO, acreditamos que é hora de pensar na sustentabilidade do início ao fim e implementá-la em todas as suas facetas. Com o LICO Fibrano® desenvolvemos um pavimento natural isento de plástico e fabricado exclusivamente a partir de materiais renováveis como madeira, cortiça, fibras naturais, borracha e outras matérias-primas naturais.

Ao mesmo tempo, criamos um revestimento de piso moderno, confortável e de alta qualidade que atende a todos os requisitos técnicos do século XXI, inclusive em termos de robustez (classe 33).

Durante o desenvolvimento do produto, foi dada especial ênfase a uma economia circular sustentável (2ª vida).



201555 Oak Levante Grey



201554 Oak Bourbon



201551 Northern Oak Silver



201552 French Cherry



201596 Northern Oak White



201530 Cognac Oak



201534 Oak Siena Taupe



201537 American Red Oak



201542 Oak Villa Natur



201541 Oak Villa Gold



201534 Oak Siena Taupe



201543 Oak Villa Light



201535 Oak Siena Dark



501546 French Oak Light



201536 Oak Siena Gold



201539 Oak Nairobi Sand



201532 Oak Siena Natural



201538 Oak Nairobi Beige



201541 Oak Villa Gold



201836 French Oak Raw AB



201837 French Oak Amber AB



201630 Mirabell Oak Raw CD



201631 Mirabell Oak Amber CD



201623 Savannah Oak Dark Grey



201626 Kaya Oak Wellington



201629 Mirabell Oak Caramell



201606 Oak Sevilla



201638 Cortina Oak Alabaster



201627 Kaya Oak Meadow



201642 Kaya Oak Light



201622 Oak Sevilla Taupe

Vinyl

Hydro Fix

Accesorios

Cork

Printcork

Lino

Fibrano

Ledo

Real Designwood

Micodur

Wall Hydro

Wall Hydro Print

Vinyl



201556 Concrete Polished White



201399 Betonstein / Concrete Stone



201327 Cement Light Ceramic

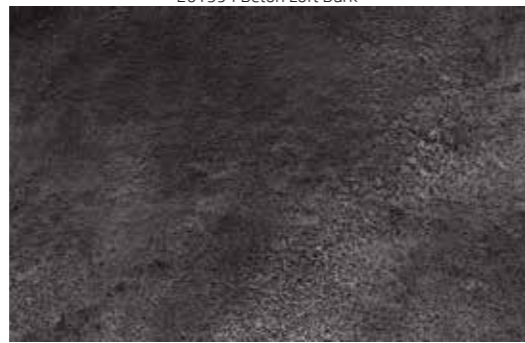

201594 Beton Loft Dark



201400 Stone Pebble



201556 Concrete Polished White



201518 Cement Ash



201621 Concrete Urban



201166 Sandstone



201598 Monte Carrara

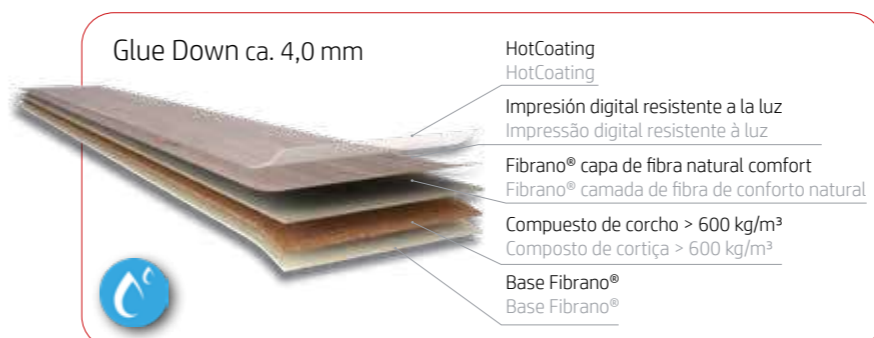
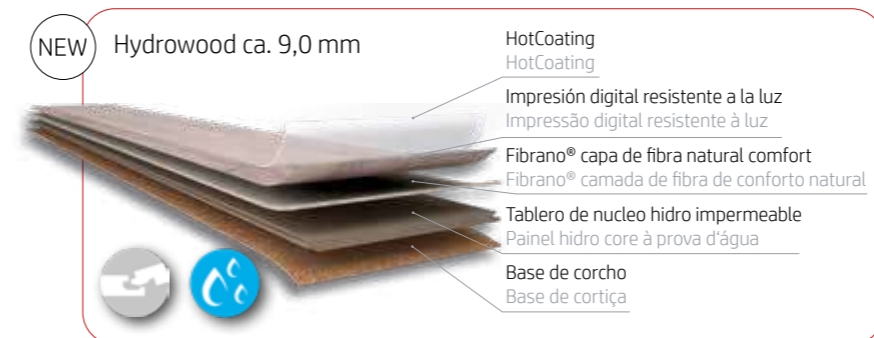
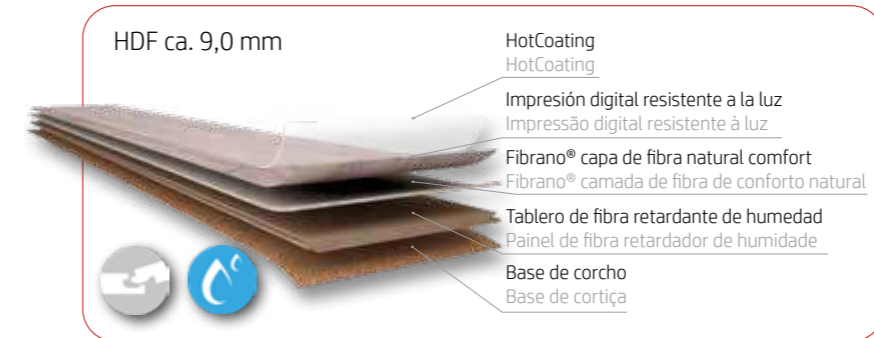

- Cálido al tacto**
Quente ao toque
- Infinita variedad de diseños**
Variedade infinita de designs
- Impacto sonoro y aislamiento acústico**
Impacto sonoro e isolamento acústico
- Uso de materia-prima regenerada**
Utilização de matéria-prima regenerada
- Aislamiento térmico**
Isolamento térmico
- Suave a la pisada**
Pé macio
- Apto para calefacción por suelo radiante**
Adequado para piso radiante

Dimensiones / Dimensões

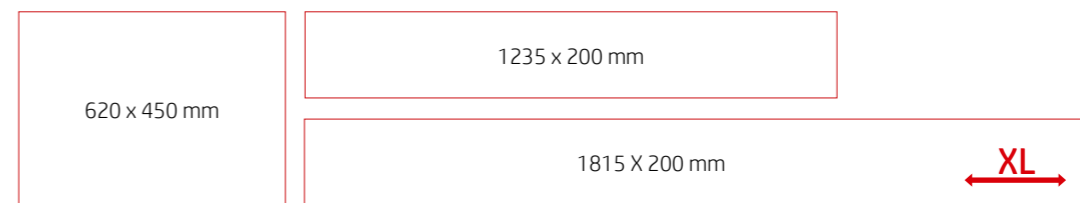

Vinyl
Hydro Fix
Accesorios
Cork
Printcork
Lino
Fibrano
Ledo
Real Designwood
Micodur
Wall Hydro
Wall Hydro Print



7PL9 Buffalo Mocca

LEDO

Refinado e inovador, con un hermoso diseño.

El suelo con acabado de cuero de LICO es un material de fibra de cuero hecho de cuero genuino, reciclado, sin cromo, látex natural, grasa natural y agentes curtientes naturales. De diseño elegante y extremadamente duradero gracias al sellado respetuoso con el medio ambiente, este suelo natural puede utilizarse para crear un ambiente único.

LICO ha incorporado todo su conocimiento y muchos años de experiencia en este sensual acabado de suelo para aumentar la sensación personal de elegancia, calidez y emoción de las personas.

Refinado e inovador, com um belo design.

O piso de couro com acabamento LICO é um material de fibra de couro feito de couro genuíno, reciclado, sem cromo, látex natural, graxa natural e agentes de bronzeamento naturais. Elegante no design e extremamente durável graças à vedação ecológica, este piso natural pode ser usado para criar um ambiente único.

A LICO incorporou todo o seu conhecimento e muitos anos de experiência neste acabamento sensual para pavimentos para realçar a sensação pessoal de elegância, calor e excitação das pessoas.

7PL2305 Boa Sand

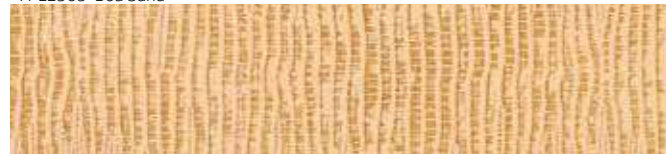

7PL2101 Toro Chocco



7PL41/119 Waran Beige



7PL2102 Toro Bordeaux



Cognac



Tobacco



7PL2102 Toro Bordeaux



7PL27 Cobra Bordeaux



7PL2306 Boa Silver



7PL2302 Boa Oxyd



7PL2301 Boa Exotic



7PL9 Buffalo Mocca



7PL2306 Boa Silver



Clase 23 / 32
Classe 23/32



Producto Natural
Produto Natural



Resistencia a la luz >7
Resistência à luz >7



Fácil mantenimiento
Manutenção fácil

HDF ca. 10,5 mm

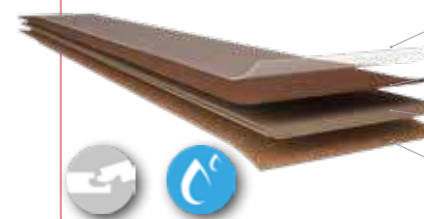

HotCoating
HotCoating
Cuero auténtico regenerado
Couro genuíno regenerado
Tablero de fibra retardante de humedad
Painel de fibra retardador de humidade
Base de corcho
Base de cortiça

Glue Down ca. 6,0 mm



HotCoating / HotCoating Light
HotCoating / HotCoating Light
Cuero auténtico regenerado
Couro genuíno regenerado
Base de corcho
Base de cortiça

Cálido al tacto
Quente ao toque

Cuero sin cromo
Couro sem cromo

Impacto sonoro y aislamiento acústico
Impacto sonoro e isolamento acústico

Uso de materia-prima regenerada
Utilização de matéria-prima regenerada

Aislamiento térmico
Isolamento térmico

Suave a la pisada
Pé macio

Buffalo Mocca



Dimensiones / Dimensões

915 x 305 mm

620 x 450 mm



Produced under license of Unilin - EP nr. 0843763/AJ.S. patent nr. 6,006,486



LM - 2500



EMISSIONS DANS L'AIR INTERIEUR





Oak Classic & 201447 Native

REAL DESIGNWOOD

Robusto suelo de madera auténtica

El suelo de madera auténtica convence por sus diseños naturales y su durabilidad sin precedentes para un suelo de madera. El producto natural es fácil de cuidar y cumple con la clase de resistencia al fuego CfS1, lo que lo hace adecuado tanto para zonas residenciales como comerciales. Real DesignWood cumple con todos los requisitos de la clase de uso 33 según EN16511.

Además de los diseños naturales, la impresión digital opcional permite cumplir incluso los deseos de diseño más inusuales.

Piso de madeira real resistente

O piso de madeira verdadeira convence pelos seus padrões naturais e durabilidade sem precedentes para um piso de madeira. O produto natural é fácil de cuidar e atende à classe de resistência ao fogo CfS1, o que o torna adequado tanto para áreas residenciais quanto comerciais. O Real DesignWood cumple todos os requisitos da classe de utilização 33 de acordo com EN16511.

Além dos designs naturais, a impressão digital opcional permite satisfazer até os desejos de design mais inusitados.



- Reacción al fuego Cfl-s1**
Reação ao fogo Cfl-s1
- Cálido al tacto**
Quente ao toque
- Superficie de madera auténtica**
Superfície de madeira verdadeira
- Impacto sonoro y aislamiento acústico**
Impacto sonoro e isolamento acústico
- Uso de materia prima reciclada**
Uso de matérias-primas recicladas
- Fácil mantenimiento**
Manutenção fácil
- Libre de astillas**
Sem lascas



Dimensiones / Dimensões

1235 x 200 mm

Opcional
1235 x 200 mm

Gran variedad de diseños gracias a la tecnología de impresión digital
Grande variedade de designs graças à tecnologia de impressão digital

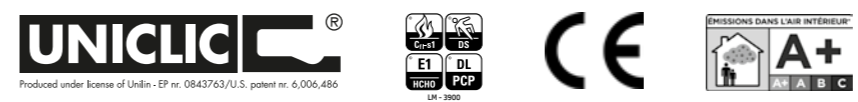

Vinyl
Hydro Fix
Accesorios
Cork
Printcork
Lino
Fibrano
Ledo
Real Designwood
Micodur
Wall Hydro
Wall Hydro Print



201309 Stone Brown

MICODUR

El fenómeno natural

Micodur: el pavimento 100 por ciento natural, tan único y versátil como sus campos de aplicación. Gracias a su estructura mineral inteligente, que aporta muchas propiedades positivas, y a la superficie impresa digitalmente, crea el puente perfecto entre funcionalidad y diseño.

Y el producto en sí no sólo es bueno para el medio ambiente; Todo el ciclo de su producto, desde la producción hasta el reciclaje, también se basa en un concepto sostenible y que ahorra recursos (2nd life).

O fenómeno natural

Micodur: o pavimento 100% natural, tão único e versátil quanto os seus campos de aplicação. Graças à sua estrutura mineral inteligente, que proporciona muitas propriedades positivas, e à superfície impressa digitalmente, cria a ponte perfeita entre funcionalidade e design.

E o produto em si não é bom apenas para o meio ambiente; Todo o ciclo do seu produto, desde a produção até a reciclagem, também se baseia em um conceito sustentável e de economia de recursos.(2nd life).

201019 Concrete Chrome



201231 Concrete Creme White



201233 Cement Iron



201020 Concrete Silver



201298 Stone Beige



201018 Concrete Terra



221059 Porto Branco



221027 Ferroconcrete



201298 Stone Beige



201312 Stone Black



201309 Stone Brown



201321 Stone Fust



201300 Stone Light

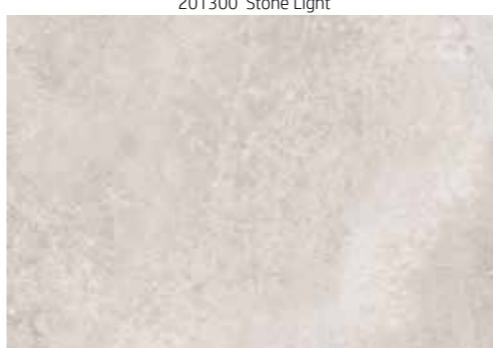

201236 Stone Ornament



201223 Stone Retro



201021 Structural Concrete White



201299 Terrazzo Grey

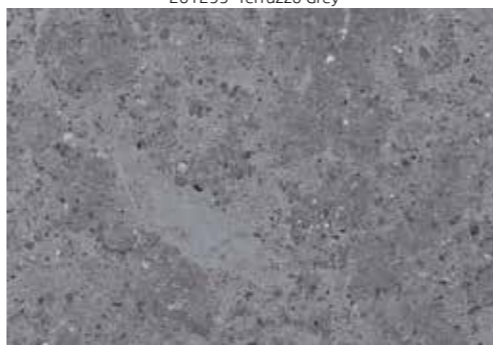

201236 Stone Ornament



201310 Terrazzo Light grey



201023 - Eco Concrete



Vinyl

Hydro Fix

Accesorios

Cork

Printcork

Lino

Fibrano

Ledo

Real Designwood

Micodur

Wall Hydro

Wall Hydro Print

201406 Oak Como Grey



201407 Oak Como Light



201405 Oak Como Natural



201421 Oak Como White



201225 Oak Light



201016 Oak Olive Flamed



200754 Oak Sierra



200970 Oak Steel



201226 Oak Vita



201024 Gold Oak



200611 Oak Craggy



200609 Sessile Oak Creme



Clase 23 / 33
Classe 23 / 33

Producto Natural
Produto Natural

2nd life

Dimensionalmente estable
Dimensionalmente estável

Impermeable
À prova d'água

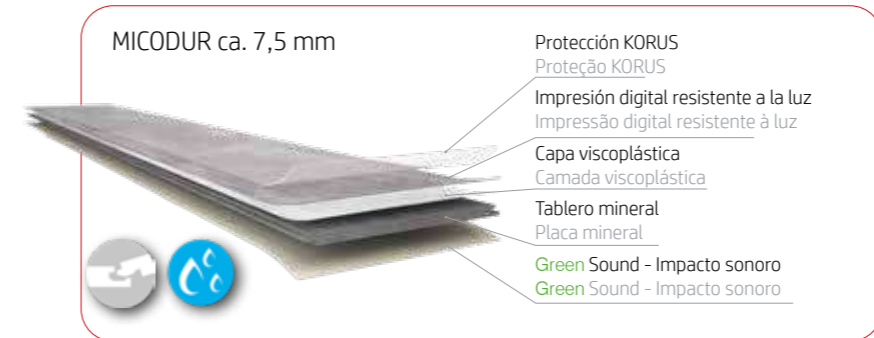

- Duradero**
Durável
- Infinitos diseños**
Projetos infinitos
- Impacto sonoro y aislamiento acústico**
Impacto sonoro e isolamento acústico
- Uso de materia prima reciclada**
Uso de matérias-primas recicladas
- Aislamiento térmico**
Isolamento térmico
- Micro bisel**
Micro moldura
- Apto para calefacción por suelo radiante**
Adequado para piso radiante
- A2fl-s1**
A2fl-s1
- Hasta 1000 m² si juntas de dilatación**
Até 1000 m² sem juntas de dilatação



Dimensiones / Dimensões

920 x 460 mm

1235 x 200 mm



Vinyl

Hydro Fix

Accesorios

Cork

Printcork

Lino

Fibrano

Ledo

Real Designwood

Micodur

Wall Hydro

Wall Hydro Print



W212 Stone Wall Ornament

WALL HYDRO

El revestimiento de pared
Revestimiento de parede

Vinyl

Hydro Fix

Accesorios

Cork

Printcork

Lino

Fibrano

Ledo

Real Designwood

Micodur

Wall Hydro

Wall Hydro Print

103

WALL HYDRO

La pared de diseño impermeable

LICO Wall Hydro son elementos de pared impermeables que se pueden instalar de forma rápida y sencilla.

Una solución perfecta para renovar o rediseñar tus paredes. Los elementos de diseño se fijan con un adhesivo de montaje adecuado y se pueden manipular fácilmente mediante la conexión machihembrada. Disponible en una amplia variedad de diseños, es una solución elegante para el revestimiento de paredes incluso en zonas húmedas.

Parede de design à prova d'água

LICO Wall Hydro são elementos de parede impermeáveis que podem ser instalados de forma rápida e fácil.

Uma solução perfeita para renovar ou redesenhar as suas paredes. Os elementos de design são fixados com um adesivo de montagem adequado e podem ser facilmente manipulados usando a conexão macho e fêmea. Disponível numa ampla variedade de designs, é uma solução elegante para revestimento de paredes mesmo em zonas húmidas.



2124-32 Cement Grey

949 Marmor Calacatta



2124-31 Cement Light



915 Cement Light Grey



2124-32 Cement Grey



3397-1 Cement Creme



6451-9 Cement Copper



4021-D02 Cement Iron



1361-37 Cement Anthrazit



Vinyl

Hydro Fix

Accesorios

Cork

Printcork

Lino

Fibrano

Ledo

Real Designwood

Micodur

Wall Hydro

Wall Hydro Print



949 Marmor Calacatta

- 
 Sin efecto telégrafo
Sem efeito telegráfico
- 
 Resistencia a la luz >6
Resistência à luz >6
- 
 Impermeable
À prova d'água
- 
 Conexión machihembrada
Conexão macho e fêmea
- 
 Paneles a la altura de la habitación
Painéis na altura da sala



Dimensiones / Dimensões



WALL HYDRO SMALL
1280 x 460 mm

WALL HYDRO XXL
935 x 2600 mm

XXL

Vinyl

Hydro Fix

Accesorios

Cork

Printcork

Lino

Fibrano

Ledo

Real Designwood

Micodur

Wall Hydro

Wall Hydro Print

WALL HYDRO PRINT

El revestimiento de pared individual

Wall Hydro Print es la solución óptima cuando el revestimiento de la pared necesita encajar perfectamente en la habitación en términos de estilo, color y diseño. La última tecnología de impresión digital permite imprimir cualquier diseño en los paneles impermeables. Ya sea para la cocina, la ducha o simplemente como elemento de diseño, con Wall Hydro Print es posible transformar cualquier habitación en un elegante oasis de bienestar en un tiempo récord.

Revestimiento de parede individual

Wall Hydro Print é a solução ideal se o revestimento de parede necessita de se adaptar perfeitamente à divisão em termos de estilo, cor e design. A mais recente tecnologia de impressão digital permite que qualquer desenho seja impresso nos painéis impermeáveis. Seja para a cozinha, para o duche ou simplesmente como elemento de design, com Wall Hydro Print é possível transformar qualquer divisão num elegante oásis de bem-estar em tempo recorde.

W224 Arcadia (Version 3D)



Todos los diseños Wall Hydro Print están también disponibles en versión 3D
Todos os designs do Wall Hydro Print também estão disponíveis na versão 3D

W258 Old Brick



W246 Oak Accent



W224 Arcadia



W226 Arcadia Light



W212 Stone Wall Ornament



W219 Stone Wall Ornament White



W227 Volterra



W228 Volterra Light



WH3D08 Ethereal Glam Gold



WH3D09 Ethereal Glam Silver



WH3D06 Latanites Light



WH3D07 Latanites Grey



Vinyl

Hydro Fix

Accesorios

Cork

Printcork

Lino

Fibrano

Ledo

Real Designwood

Micodur

Wall Hydro

Wall Hydro Print



Todos los diseños Wall Hydro Print están también disponibles en versión 3D
Todos os designs do Wall Hydro Print também estão disponíveis na versão 3D



Todos los diseños Wall Hydro Print están también disponibles en versión 3D
Todos os designs do Wall Hydro Print também estão disponíveis na versão 3D

W229 Concrete Polished White



W231 Moonstone Bronze



W233 Moonstone Silver



W234 Cement Gres



W221 Florence Copper



W247 Terrazo Savona



W262 Ancient Light



W261 Ancient Bronze



W261 Ancient Bronze



W223 Valentia



W248 Vintage Tiles



W213 Indian Fall



W252 Letter Beige



W271 Nautilus White



W272 Turquoise Paint



W274 Diamonds



W273 Retro Concreto



W267 Metallic Art



W268 Metallic Art Gold



W264 Lima Light



W263 Lima Turquoise



Vinyl

Hydro Fix

Accesorios

Cork

Printcork

Lino

Fibrano

Ledo

Real Designwood

Micodur

Wall Hydro

Wall Hydro Print

WALL HYDRO PRINT

El revestimiento de la pared individual
Revestimento de parede individual



Todos los diseños Wall Hydro Print están también disponibles en versión 3D
Todos os designs do Wall Hydro Print também estão disponíveis na versão 3D

W265 Maiolica Azur



W266 Maiolica Colors



W217 Copper Leaves



W218 Silver Leaves



W217 Copper Leaves (Versión 3D)



Sin efecto telégrafo
Sem efeito telegráfico



Resistencia a la luz >7
Resistência à luz >7



Impermeable
À prova d'água



Conexión machihembrada
Conexão macho e fêmea



Paneles a la altura de la habitación
Painéis na altura da sala

Wall Hydro Print ca. 4,5 mm

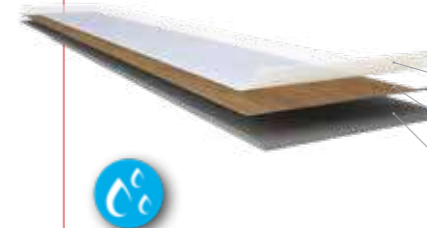

Capa superior de PU
Camada superior de PU
Impresión digital resistente a la luz
Impressão digital ultrarrápida
Capa acústica impermeable
Camada acústica impermeável

Dimensiones / Dimensões

WALL HYDRO PRINT SMALL
1280 x 460 mm

WALL HYDRO PRINT XXL
935 x 2600 mm

XXL

W231 Moonstone Bronze



Vinyl

Hydro Fix

Accesorios

Cork

Printcork

Lino

Fibrano

Ledo

Real Designwood

Micodur

Wall Hydro

Wall Hydro Print



DIRECTOS DE FÁBRICA DIRETO DA FÁBRICA

LICO IBÉRICA nace como extensión de la fábrica de producción LICO AG, ubicada en Münstair (Suiza), para introducirse en el mercado de España, Portugal y Andorra.

Presentamos soluciones de alta calidad en el mundo de los suelos y revestimientos de pared con una producción sostenible Made in Suiza.

La fábrica ocupa una superficie de 42.000 m2, de los cuales 26.000 m2 son áreas de producción. Disponemos de tres almacenes en España para ofrecer un servicio rápido a nuestros clientes.

Con estas bases, LICO IBÉRICA es una empresa sólida y con gran experiencia, que ofrece a sus clientes la mejor CALIDAD, SERVICIO Y PRECIO.

A LICO IBÉRICA foi criada como uma extensão da fábrica de produção da LICO AG, localizada em Münstair (Suíça), para entrar no mercado de Espanha, Portugal e Andorra.

Apresentamos soluções de alta qualidade no mundo dos pavimentos e revestimentos de parede com produção sustentável Made in Switzerland.

A fábrica ocupa uma área de 42 mil m2, dos quais 26 mil m2 são áreas de produção. Dispomos de três armazéns em Espanha para oferecer um serviço rápido aos nossos clientes.

Com estas bases, a LICO IBÉRICA é uma empresa sólida e com grande experiência, que oferece aos seus clientes a melhor QUALIDADE, SERVIÇO E PREÇO.

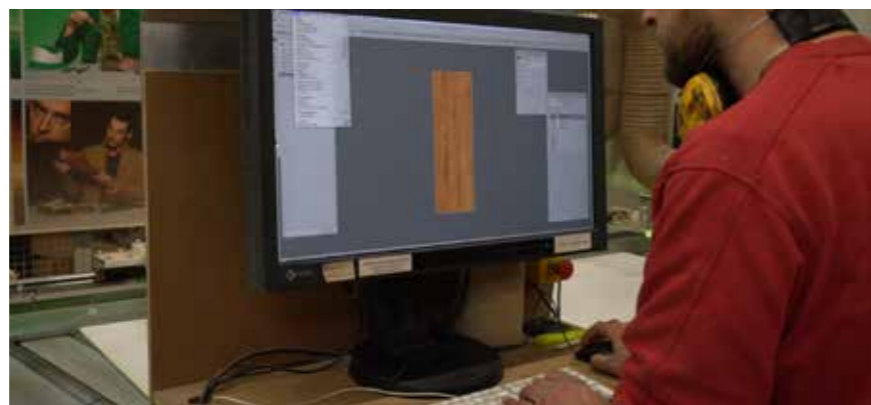



www.licoiberica.com